

CAM550

User Manual



Federal Communications Commission Statement

NOTE: This equipment has been tested and found to comply with the limits for a Class A digital device, pursuant to part 15 of the FCC Rules. These limits are designed to provide reasonable protection against harmful interference when the equipment is operated in a commercial environment. This equipment generates, uses, and can radiate radiofrequency energy and, if not installed and used in accordance with the instruction manual, may cause harmful interference to radio communications. Operation of this equipment in a residential area is likely to cause harmful interference in which case the user will be required to correct the interference at his own expense.

FCC Caution: Any changes or modifications not expressly approved by the party responsible for compliance could void the user's authority to operate this equipment.

This device complies with part 15 of the FCC Rules.

Operation is subject to the following two conditions:

- (1) This device may not cause harmful interference, and
- (2) this device must accept any interference received, including interference that may cause undesired operation.

Warning:

This is a class A product. In a domestic environment this product may cause radio interference in which case the user may be required to take adequate measures.

This Class A digital apparatus complies with Canadian ICES-003. Cet appareil numérique de la classe A est conforme à la norme NMB-003 du Canada.

この装置は、クラス A 機器です。この装置を住宅環境で使用すると電波妨害を引き起こすことがあります。この場合には使用者が適切な対策を講ずるよう要求されることがあります。

VCCI-A

사 용 자 안 내 문	
이 기기는 업무용 환경에서 사용할 목적으로 적합성평가를 받은 기기로서 가정용 환경에서 사용하는 경우 전자파간섭의 우려가 있습니다.	
※ 사용자 안내문은 "업무용 방송통신기자재"에만 적용됩니다.	

기종별	사용자안내문
A 급 기기 (업무용 방송통신기자재)	이 기기는 업무용(A 급) 전자파적합기기로서 판매자 또는 사용자는 이 점을 주의하시기 바라며, 가정외의 지역에서 사용하는 것을 목적으로 합니다.

DISCLAIMER

No warranty or representation, either expressed or implied, is made with respect to the contents of this documentation, its quality, performance, merchantability, or fitness for a particular purpose. Information presented in this documentation has been carefully checked for reliability; however, no responsibility is assumed for inaccuracies. The information contained in this documentation is subject to change without notice.

In no event will AVer Information Inc. be liable for direct, indirect, special, incidental, or consequential damages arising out of the use or inability to use this product or documentation, even if advised of the possibility of such damages.

TRADEMARKS

“AVer” is a trademark owned by AVer Information Inc. Other trademarks used herein for description purpose only belong to each of their companies.

COPYRIGHT

©2022 AVer Information Inc. All rights reserved.

All rights of this object belong to AVer Information Inc. Reproduced or transmitted in any form or by any means without the prior written permission of AVer Information Inc. is prohibited. All information or specifications are subject to change without prior notice.

NOTICE

SPECIFICATIONS ARE SUBJECT TO CHANGE WITHOUT PRIOR NOTICE. THE INFORMATION CONTAINED HEREIN IS TO BE CONSIDERED FOR REFERENCE ONLY.

WARNING

- To reduce risk of fire or electric shock, do not expose this appliance to rain or moisture. Warranty will be void if any unauthorized modifications are done to the product.
- Do not drop the camera or subject it to physical shock.
- Use correct power supply voltage to avoid damaging camera.
- Do not place the camera where the cord can be stepped on as this may result in fraying or damage to the lead or the plug.
- Hold the bottom of the camera with both hands to move the camera. Do not grab the lens or lens holder to move the camera.

Remote Control Battery Safety Information

- Store batteries in a cool and dry place.
- Do not throw away used batteries in the trash. Properly dispose of used batteries through specially approved disposal methods.
- Remove the batteries if they are not in use for long periods of time. Battery leakage and corrosion can damage the remote control. Dispose of batteries safely and through approved disposal methods.
- Do not use old batteries with new batteries.
- Do not mix and use different types of batteries: alkaline, standard (carbon-zinc) or rechargeable (nickel-cadmium).
- Do not dispose of batteries in a fire.
- Do not attempt to short-circuit the battery terminals.

CAUTION

- Risk of explosion if battery is replaced by an incorrect type.
- Dispose of used batteries in a safe and proper manner.

遥控器电池安全信息

- 请将电池存放在凉爽与干燥的位置。
- 不要将电量用尽的电池弃置在家庭废弃物中。请将电池弃置在特定回收处，或送回原购买的商店。
- 如果长时间不使用电池，请将其取出。电池漏液与腐虫可能会损坏遥控器，请以安全方式弃置电池。
- 不可混用新旧电池。
- 不可混用不同类型的电池：碱性、标准（碳锌）或可充电（镍镉）电池。
- 不可将电池弃置于火源中。
- 请勿尝试让电池端子短路。

More Help

For FAQs, technical support, software and user manual download, please visit:

Headquarters

Download Center: <https://www.aver.com/download-center>
Technical Support: <https://www.aver.com/technical-support>

USA Branch office

Download Center: <https://www.averusa.com/business/support/>
Technical Support: <https://averusa.force.com/support/s/contactsupport>

Europe Branch office

Download Center: <https://www.avereurope.com/download-center>
Technical Support: <https://www.avereurope.com/technical-support>

Contact Information

Headquarters

AVer Information Inc.
<https://www.aver.com>
8F, No.157, Da-An Rd., Tucheng Dist., New Taipei City 23673, Taiwan
Tel: +886 (2) 2269 8535

USA Branch office

AVer Information Inc., Americas
<https://www.averusa.com>
668 Mission Ct., Fremont, CA 94539, USA
Tel: +1 (408) 263 3828
Toll-free: +1 (877) 528 7824
Technical support: support.usa@aver.com

Europe Branch office

AVer Information Europe B.V.
<https://www.avereurope.com>
Westblaak 134, 3012 KM, Rotterdam, The Netherlands
Tel: +31 (0) 10 7600 550
Technical support: eu.rma@aver.com

Japan Branch Office

アバー・インフォメーション株式会社
<https://jp.aver.com>
〒160-0023 日本東京都新宿区西新宿 3-2-26 立花新宿ビル 7 階
Tel: +81 (0) 3 5989 0290
テクニカル・サポート: VCInfo.JP@aver.com

Vietnam Branch Office

Công ty TNHH AVer Information (Việt Nam)
Tầng 5, 596 Nguyễn Đình Chiểu, P.3, Quận 3, Thành phố Hồ Chí Minh 700000, Việt Nam
Tel: +84 (0)28 22 539 211

Contents







Package Contents	1
Product Introduction	2
Overview	2
LED Indicator	3
Remote Control	4
Pan and Tilt Angle	8
Installation	9
Device Connection	9
Power Connection	11
HDMI Connection	12
RS232 Connection	14
Wall Mount Installation	20
Ceiling Mount Installation (Optional)	23
Secure the Cables	27
Operating the Camera	28
Make a Video Call	28
Make a Connection through the Browser	28
Web Settings	31

First Time Login	31
Live Screen Operation	32
Set Up the Preset.....	33
User can set 10 preset positions.....	33
Camera Settings	35
Tracking Mode	35
Framing Speed	38
Framing Size	38
Gesture Control	39
Sleep Position.....	41
Sleep Timer	41
On Screen Menu	41
Camera Binding.....	41
HDMI Screen Layout.....	42
Image Settings	43
Frequency.....	43
White Balance	43
Noise Reduction	43
Brightness.....	44

Saturation	44
RS232 Settings.....	45
Video Format Settings	46
H.264 Profile.....	46
IP Stream Resolution only	46
Frame Rate.....	47
Bit Rate.....	47
RTSP	47
RTMP	48
Network Settings.....	49
DHCP	49
Static IP	49
System Settings.....	51
Language.....	51
Firmware Update	51
Factory Default	52
Camera Reboot	52
Change Password	53
SSL Certificate.....	54

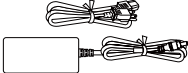
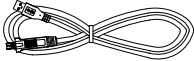
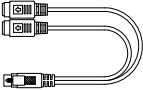
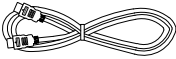
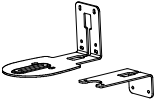

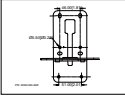

Date Format.....	54
Time Format	54
Time Correction Mode	55
Information.....	56
PTZApp 2.....	57
Install PTZApp 2	57
Use PTZApp 2 with USB Devices.....	57
Use PTZApp 2 with a Virtual Stream	65
EZLive.....	67
Use AVer EZLive	67

Package Contents

Camera Unit	Remote Control	Power Adapter & Power Cord*	USB 3.1 Type-B to Type-A Cable (3m)
			
Mini DIN9 to Mini DIN8 RS232 Adapter Cable	HDMI Cable (3m)	Wall Mount	Screws for Mount
			 M4 x8mm (x2)
Tripod Screw	Drilling Paper	QR Code Card	
 1/4"-20 L=7.5mm (x2)			

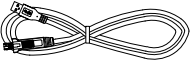
* The power cord will vary depending on the standard power outlet of the country where it is sold.

Optional Accessories

USB 2.0 Type-B to Type-A Cable (5m)	Mini DIN8 to D-Sub9 Cable	Foldable TV Mount	USB 3.1 Extender 10m/20m/30m
			
Ceiling Mount**			
			

*Optional Accessories will vary depending on the country where it is sold.

**This is a dual lens camera and doesn't support upside down installation. To mount on ceiling, please purchase ceiling mount from AVer.

Product Introduction

Overview

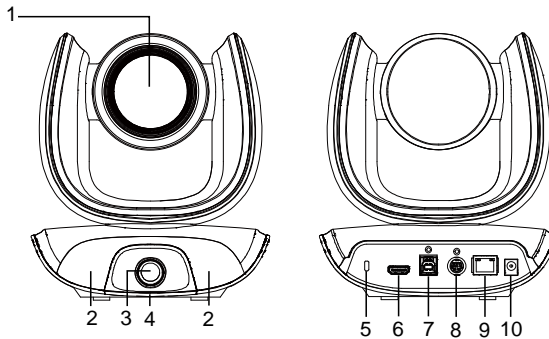

- | | | | |
|---|-------------------|----|---------------------|
| 1 | Optical Zoom Lens | 6 | HDMI Port** |
| 2 | IR Sensor | 7 | USB 3.1 Type B Port |
| 3 | AI Lens* | 8 | RS232 In/Out Port |
| 4 | Status LED | 9 | PoE Port*** |
| 5 | Kensington Lock | 10 | DC 12V Power Jack |

* AI Lens:

Users can see AI lens preview image in PTZApp 2, IP web page or HDMI out to check camera installation location.

AI lens is used to detect participants within its 95 degree field of view to trigger optical zoom lens to track people in the room. It doesn't support ePTZ. Please don't put the camera on table because the AI lens view will be blocked. The suggested installation height is at least 1.5m.

** HDMI out streaming supports picture in picture (PIP) function. For more details, please refer to HDMI Connection on page 11.

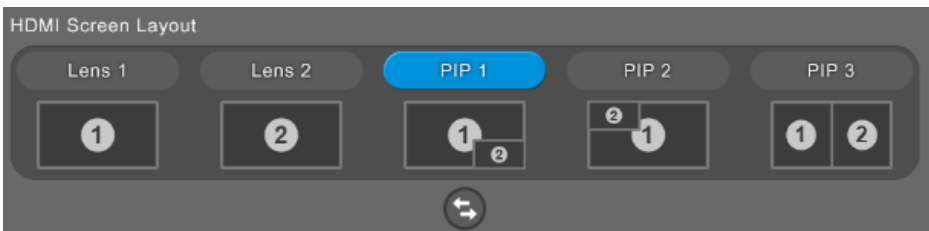

*** Power over Ethernet (PoE) is compatible with IEEE 802.3at/802.3af. Please use a CAT 5e FTP cable (not included).

LED Indicator

Solid blue: Power on

Solid red: Start-up

Solid orange: Only power cable connected

Solid blue: Video on

Solid white: USB cable is connected but camera doesn't have any streaming out

Gesture control

Blue light blinks for 2 seconds: Successfully wake up gesture control function by any valid gesture command.

Blue light blinks for 4 seconds: Camera recognizes a valid gesture command and start to action.

[Note] The default of gesture control is off. Please enable it via PTZApp 2 or IP web page. The effective distance is up to 5-meter away from the camera. (Please refer to page 39)

Remote Control

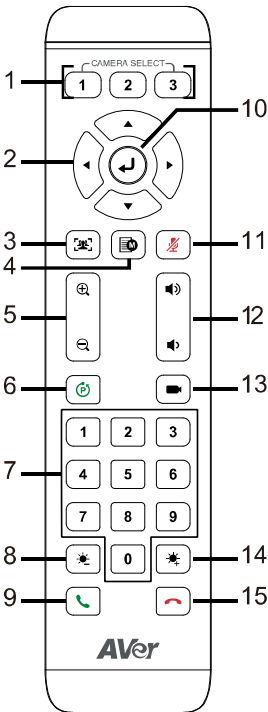

Name	Function
<p>1. Camera Select</p>	<p>One remote can control up to 3 AVer VC/CAM/VB series cameras. You can use AVer PTZApp 2 or IP web page to set numbers associated with each camera, and then select which camera you would like to control using the remote.</p> <p>[Note] The default is Off. If you don't do any binding, no matter you press camera 1 or 2, 3 button on the remote control, you can control all the AVer USB cameras around you.</p>
<p>2. Camera Directional Control</p>	<p>Use the directional buttons on the remote to control the direction of the camera. Press the directional button to move the camera or press and hold to continuously pan or tilt.</p>
<p>3. SmartFrame</p>	<p>One-click automatic field of view adjustment to fit all participants. Press for 1~2 seconds to switch the SmartFrame function among Manual Framing/Auto Framing/Preset Framing modes.</p> <p>A message (as figures shown) will display on the screen to indicate the mode while using HDMI out function.</p> <div style="display: flex; justify-content: space-around; margin: 10px 0;"> <div style="background-color: black; color: white; padding: 5px 10px; border: 1px solid black;">Manual Framing</div> <div style="background-color: black; color: white; padding: 5px 10px; border: 1px solid black;">Auto Framing</div> </div> <div style="background-color: black; color: white; padding: 5px 10px; border: 1px solid black; margin: 10px 0; width: fit-content;">Preset Framing</div> <p>While in Auto Framing mode, or doing one-click manual frame, an icon message (as figure shown) will display on the upper left screen to indicate that the framing action is triggered. The icon will appear 2~3 seconds on</p>

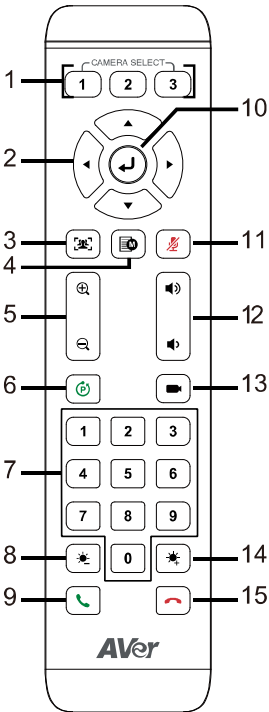

the screen while using HDMI out function. Once the framing process is done, it will disappear. If you don't want to see the icon display, please go to PTZApp 2, find "On Screen Menu" function and select "Off".



[Notes]

- Default is Manual Framing. SmartFrame deploys face and body detection technology. People wearing masks and side facial profiles can still be detected. The maximum detection distance is 7~10 meters away from the camera.
- Camera will track people while moving. It will start to focus and zoom in once people stop moving for 1~5 seconds, depending on the framing speed you choose. The default framing speed is "Middle" speed. "High" speed is more suitable for one person tracking.
- Preset Framing: Set up preset points in advance (Only for Preset points 1~9. Preset 0 is for home position). Camera tracks one presenter and shoots the preset areas instead of focusing and zooming into presenter. The preset areas must be within the viewing area of AI lens.

4. OSD Menu

Short press the button to pull up OSD menu while using HDMI out function. Hold it for 1 sec. to select camera layout (PIP).

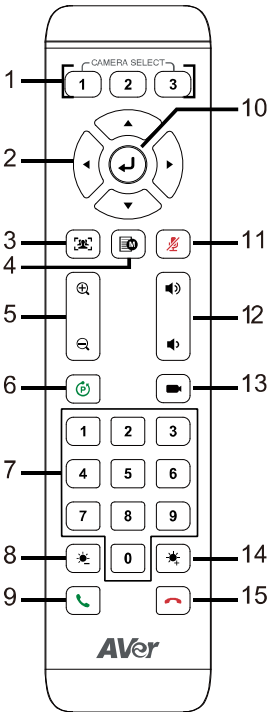

5. Zoom In/Out

Increase/Decrease the camera zoom.

6. Preset

The Preset button on the remote serves 2 functions.

To Save a Preset – Move camera to desired position. Press and hold the preset button until you receive the save message on the screen. Select preset position button 0-9 to store the current camera position. Repeat steps if needed.

To Load a Preset - Press the preset button and preset position button 0-9 to load a saved camera position. Repeat steps if needed.

7. Preset Position/Number Buttons

Preset position buttons are used in conjunction with the Preset button to save positions. There are a total of 10 presets.

Press the preset button first and then press 0-9 for the camera to move to the saved position.

[Notes]

- Press and hold the number button “**1**” for 1 second to turn on or off the WDR function.
- Press and hold the number button “**5**” for 1 second to turn on or off the SmartFrame function.
- Press and hold the number button “**8**” for 1 second to enable or disable RTMP streaming function.
- Press and hold the number button “**9**” for 1 second to force camera to enter sleep mode. This will end any IP or HDMI out video streaming. To wake up the camera, press the button or any directional button for 1 second. This mode is

not functional while USB streaming is on.

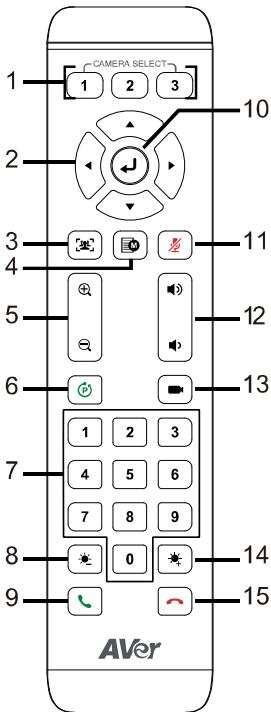

- | | |
|-------------------------------|---|
| 8. Brightness - | Decrease the brightness of the video image. |
| 9. Call/Answer | Answer a call or start a call. Not supported for CAM550. |
| 10. Enter | Click the button to show current AI mode while using HDMI out function. |
| 11. Mute/Un-mute Speakerphone | Mute/Un-mute the speakerphone. Not supported for CAM550. |
| 12. Volume Up/Down | Adjust volume up or down. Not supported for CAM550. |
| 13. Preset Hot Key | After saving positions, press to move the camera to the preset position the user has set. |
| 14. Brightness + | Increase the brightness of the video image. |
| 15. Hang Up | End the call. Not supported for CAM550. |

Pan and Tilt Angle

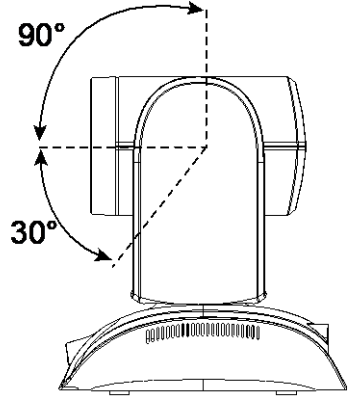
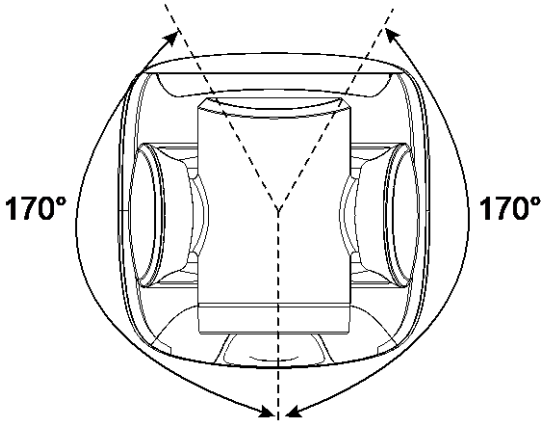

Installation

Device Connection

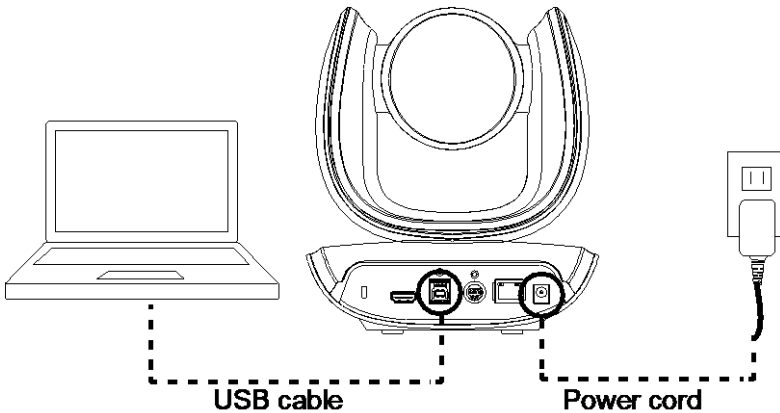

1. Use USB cable to connect the CAM550 to your PC/laptop (refer to diagram above).
2. Connect the power to the CAM550; power indicator will light up and camera head will rotate.
3. Install PTZApp 2 on laptop or PC that is connected with CAM550. The app can be used to adjust and setup the parameters of the camera (refer to the section of PTZApp 2).
4. To make a call, run your video application (Zoom, Microsoft® Teams, Skype for Business, Skype, Google Meet, Intel® Unite™, RingCentral, BlueJeans, V-Cube, LiveOn, CyberLink U Meeting®, TrueConf, Adobe Connect, Cisco WebEx®, Fuze, GoToMeeting™, Microsoft® Lync™, Vidyo, vMix, WebRTC, Wirecast, XSplit, etc.). Select CAM550 as your video device.
5. AI lens is used to detect participants within its 95 degree field of view to trigger optical zoom lens to track people in the room. Please don't put the camera on table because the AI lens view will be blocked. The suggested installation height is at least 1.5m. The camera's working distance is 1.5m. People stand too close (within 1m away) to the camera may cause bad framing performance.
6. Please note that the angle of AI lens is larger than PTZ camera. If people at two sides of meeting room sit within AI lens view but out of PTZ lens' widest angle, they won't be framed and appear in the view of PTZ lens successfully. When you see the warning message, please come closer to make sure people at two sides can be within PTZ camera's viewing angle. "You are outside of the PTZ Lens' viewing angle. Please come closer."

[Note]

- Use the USB 3.1 cable included in the package.
- CAM550 has the USB 3.1 port which is USB 2.0 compatible.

Maximum resolution/fps for USB 2.0 and USB 3.1 port are shown below.

USB 2.0		USB 3.1		HDMI
YUV	M-JPEG	YUV	M-JPEG	
- 640x480 or less resolution, up to 30fps - 720p, up to 10fps	- 1080p/60fps	- Up to 1080p/30fps - 720p/60fps	- Up to 4k/30fps - 1080p/60fps	1080p/60fps 1080p/30fps

Power Connection

The power supply can be plugged into the wall outlet or drawn from PoE switch (Ethernet).

Wall outlet

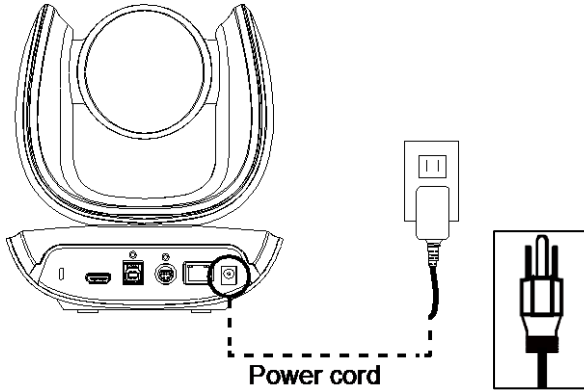

PoE

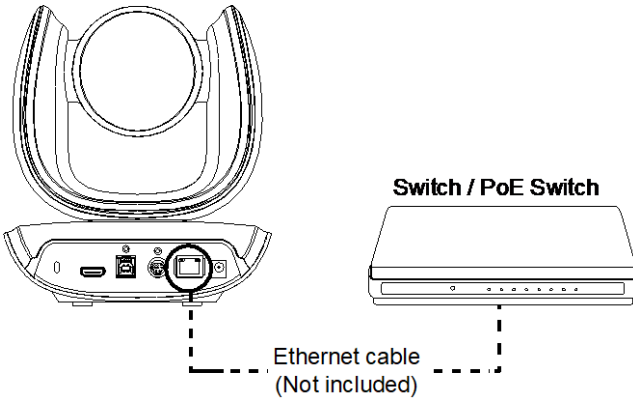

[Note] To ensure stability of IP video streaming, please use CAT 5e FTP cable (not included).

HDMI Connection

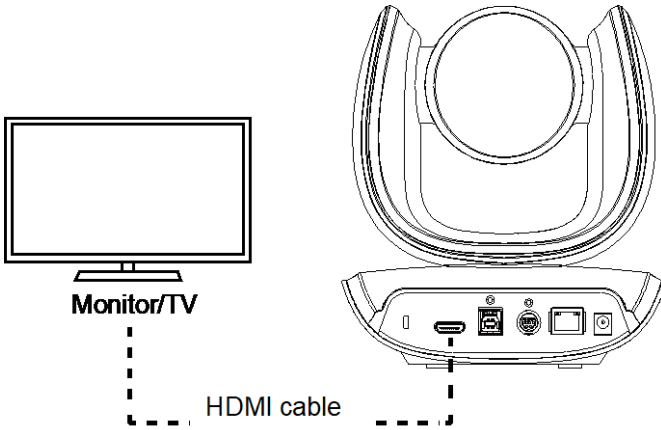

Connect with TV or monitor through the HDMI port to display camera video on the screen.

Hold  button for 1 second on remote control to call out the screen layout option. Select the camera image layout firstly. The default is PIP1, showing optical zoom lens image as main screen and AI lens image as small view. Under this layout, you can switch two cameras by pressing Up/Down on remote control.

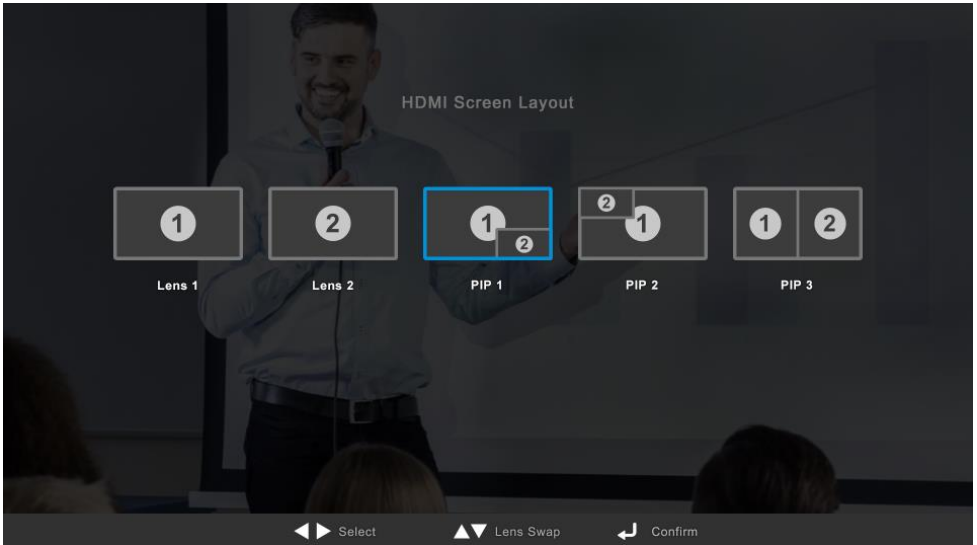

PIP view

Lens 1 The PTZ camera focuses on speaker



Lens 2 Shows all participants

After choosing the image layout, short press the OSD menu button and then the setting page will show up. Press right direction button to enter and configure the parameters of the camera. Short press the OSD button twice or hold it for 1 sec. to leave. The HDMI OSD setting function is the same as Web configuration interface. Please refer Web Settings on page 29 for more details.



RS232 Connection

■ Camera RS232 Port Pin Definition

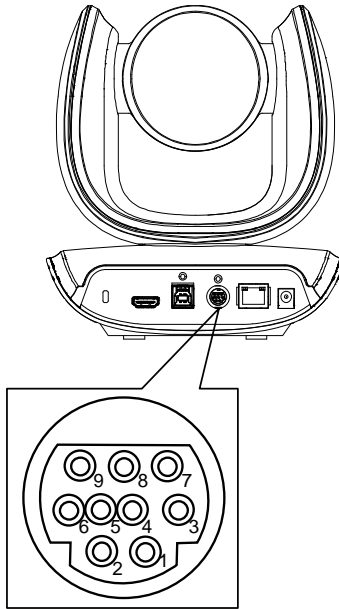

Function	Mini DIN9 PIN #	I/O Type	Signal	Description
VISCA IN	1	Output	DTR	Data Terminal Ready
	2	Input	DSR	Data Set Ready
	3	Output	TXD	Transmit Data
	6	Input	RXD	Receiver Data
VISCA OUT	7	Output	DTR	Data Terminal Ready
	4	Input	DSR	Data Set Ready
	8	Output	TXD	Transmit Data
	9	Input	RXD	Receiver Data
	5	---	---	---

Computer/Keyboard Controller and Camera Connection

Direct Connection

If users do not use AVer RS232 adapter cable, please refer to the pin connection shown below.

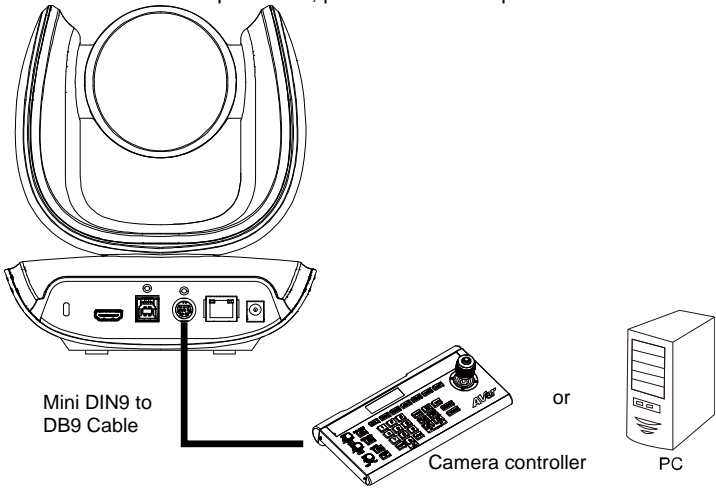

Camera (Mini DIN9)	Camera controller or PC (DB9)
1. DTR (IN)	1. DCD
2. DSR (IN)	2. RXD
3. TXD (IN)	3. TXD
6. RXD (IN)	4. DTR
7. DTR (OUT)	5. GND
4. DSR (OUT)	6. DSR
8. TXD (OUT)	7. RTS
9. RXD (OUT)	8. CTX
	9. RI

Use the supplied RS232 mini DIN9 to mini DIN8 cable

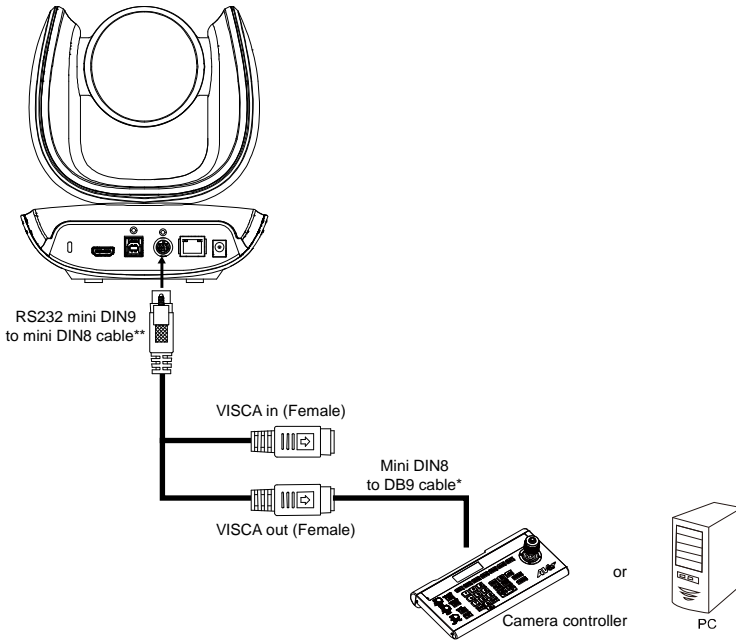

Camera controller or PC
(DB9)

1. DCD
2. RXD
3. TXD
4. DTR
5. GND
6. DSR
7. RTS
8. CTX
9. RI

Camera
(Mini DIN8)

1. DTR (IN)
2. DSR (IN)
3. TXD (IN)
4. GND (IN)
5. RXD (IN)
6. GND (IN)
1. DTR (OUT)
2. DSR (OUT)
3. TXD (OUT)
4. GND (OUT)
5. RXD (OUT)
6. GND (OUT)

* Mini DIN8 to D-Sub9 (DB9) cable 064AOTHERBPK is an optional item.

**** RS232 mini DIN9 to mini DIN8 Cable Pin Definition**

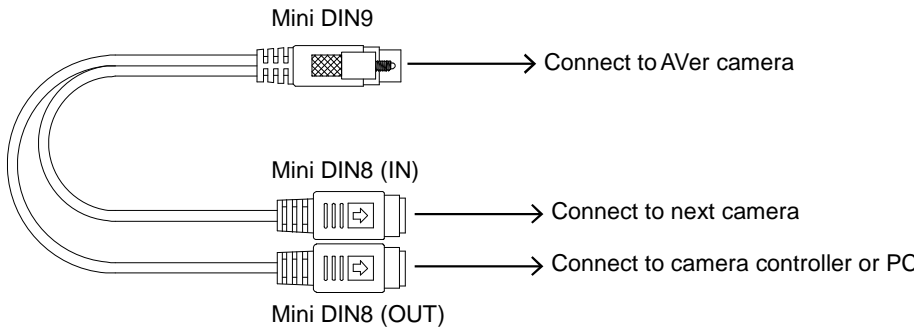

Mini DIN8 Pin Definition

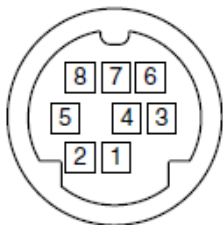

No.	Pin
1	DTR
2	DSR
3	TXD
4	GND
5	RXD
6	GND
7	NC
8	NC

■ Camera Cascade Connection

Direct Connection

If users do not use AVer RS232 adapter cable, please refer to the pin connection shown below for cascading cameras.

Total can connect up to 7 cameras.

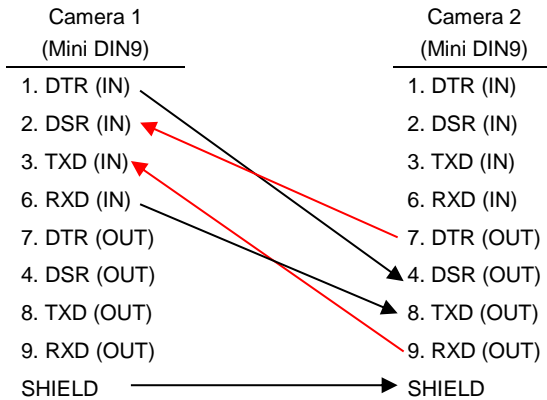
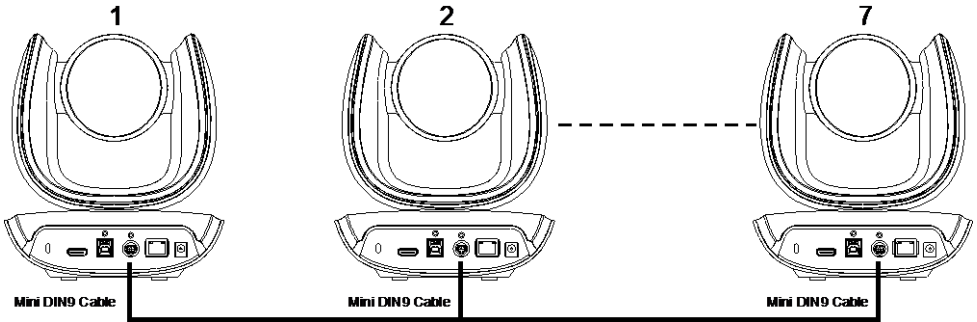

Use the RS232 mini DIN9 to mini DIN8 cable

Total can connect up to 7 cameras.

To facilitate the camera cascade, users can use AVer RS232 adapter cable.

Connect camera with AVer mini DIN9 to mini DIN8 adapter cable. Connect the mini DIN8 female side to male mini DIN8 Visca cable (Users have to buy it in the market) and then connect AVer mini DIN9 to mini DIN8 adapter cable again to connect to next camera.

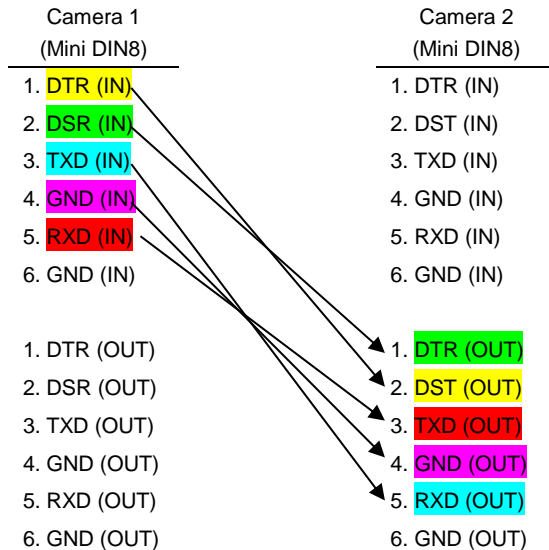
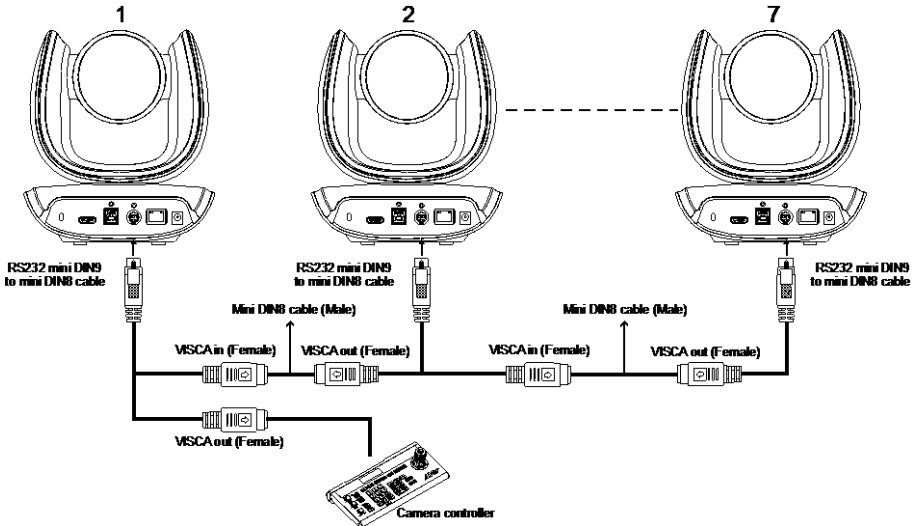

Wall Mount Installation

1. Use the drilling paper included in the package to drill the holes in the wall where the user wants to mount the camera.

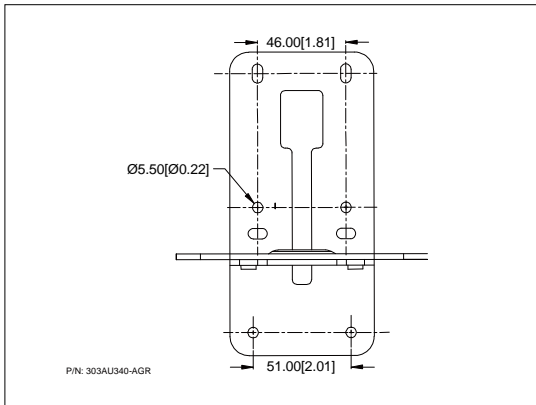

2. Use the screws (not included) to secure the L-mount bracket **A** on the wall.

Screw

For Cement wall: M4 x20mm self-tapping screws (x4) + Plastic conical anchor

For Wooden wall: M4 x20mm self-tapping screws (x4)

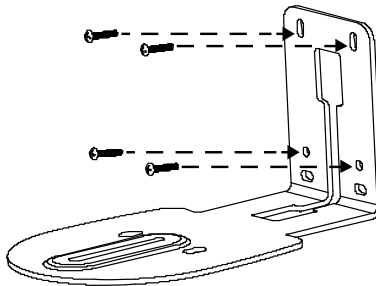

3. Then, assemble the L-mount brackets **A** + **B** with screws (included in package).

Screw size:  M4 x8mm (x2)

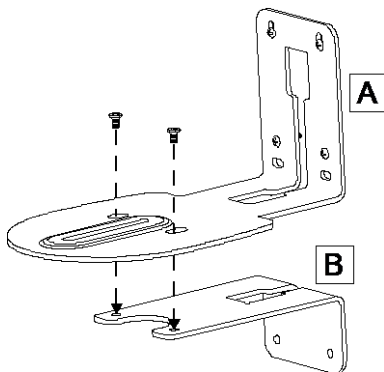

4. After assembling the L-mount brackets, use the screws (not included) to secure the lower part of L-mount brackets on the wall.

Screw

For Cement wall: M4 x20mm self-tapping screws (x2) + Plastic conical anchor

For Wooden wall: M4 x20mm self-tapping screws (x2)

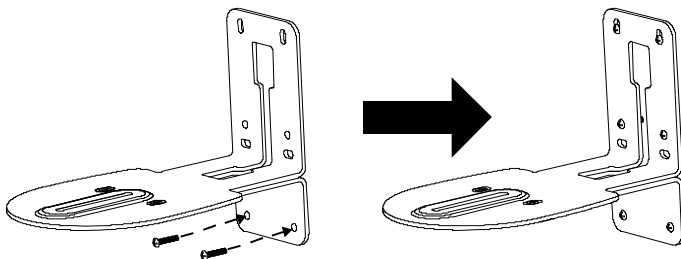

5. Pass the cables through the hole on the L-mount bracket and connect the cables to corresponding connection ports.

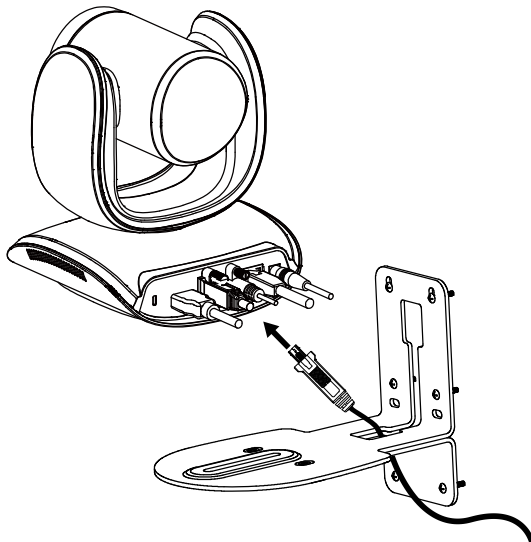

6. Use the remaining screws (included in package) to secure the camera on the L-mount bracket.

Screw:  1/4"-20 L=7.5mm (x2)

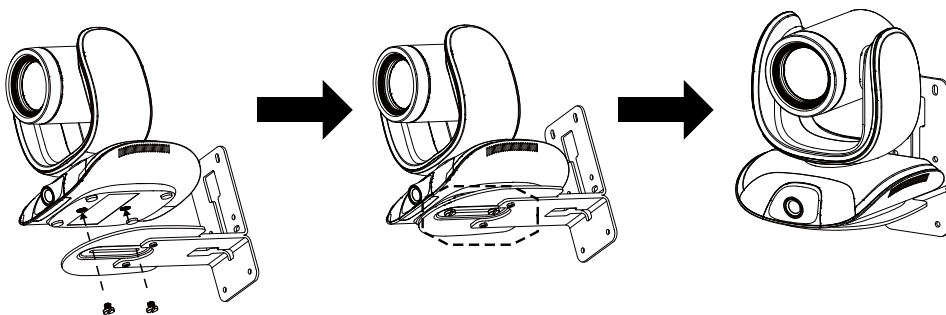

Ceiling Mount Installation (Optional)

You can use the optional ceiling mount accessories to mount the camera to the ceiling.

Package Content

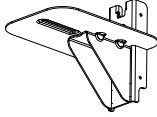
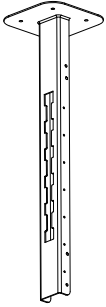

Mount bracket x 1

Camera bracket x 1

Back cover x 1

Screw (M4*8) x 8

Washer x 8

Dimension

Unit=mm

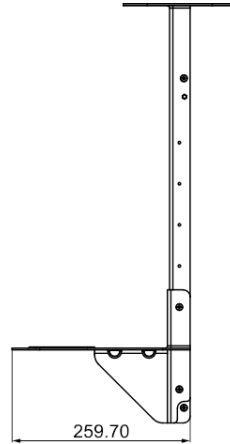
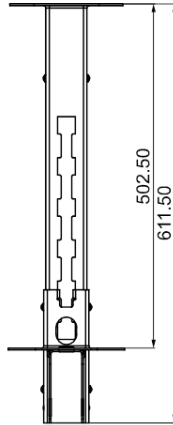
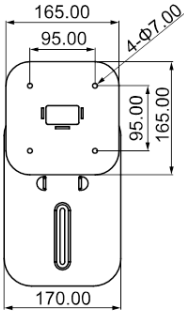

To mount the camera to the ceiling:

1. Drill the hole on the ceiling. Use screw to secure the mount bracket on the ceiling.

Screw: 4 M6 x 50mm (Not included in package)

2. Use the supplied screws with washers to secure the camera bracket to the mount bracket.

Screw: 4 M8 x 4 + 4 Washer

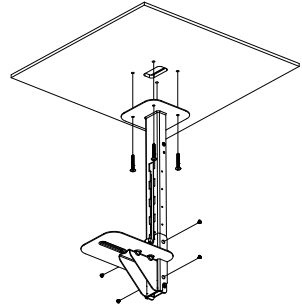

-
3. Connect all cables on the camera and pass all cables out through the hole on the mount bracket. Then, secure the camera on the camera bracket.

Screw: 2 UNC-1/4"-20 (Not included in package)

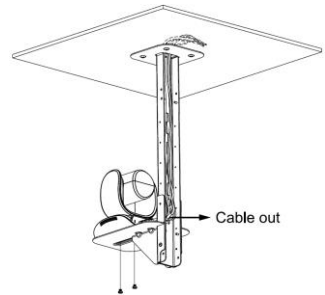

-
4. Organize all cables to go out from top or bottom of mount bracket.
 5. Then, secure the back cover with screws and washer.

Screw: 4 M8 x 4 + 4 Washer

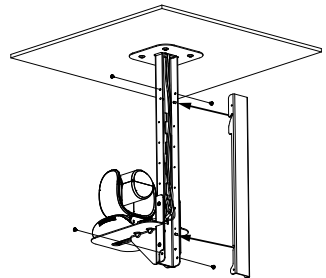

-
6. Completed.

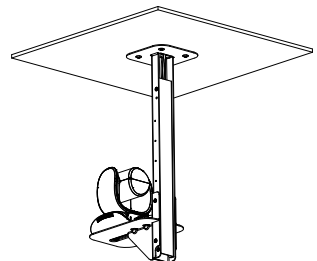

To mount the camera to the calcium silicate ceiling:

1. Please purchase support bracket for supporting camera mount bracket on calcium silicate ceiling. Then, secure the support bracket on the light steel frame structure.
2. Drill the hole on the calcium silicate ceiling. Open a hole on the calcium silicate ceiling to allow camera cables to pass through.
3. Then, secure the mount bracket, calcium silicate ceiling and support bracket together.

Screw: 4 Wingnut + 4 M6x50mm (Not included in package)

4. Use the supplied screws with washers to secure the camera bracket to the mount bracket.

Screw: 4 M8 x 4 + 4 Washer

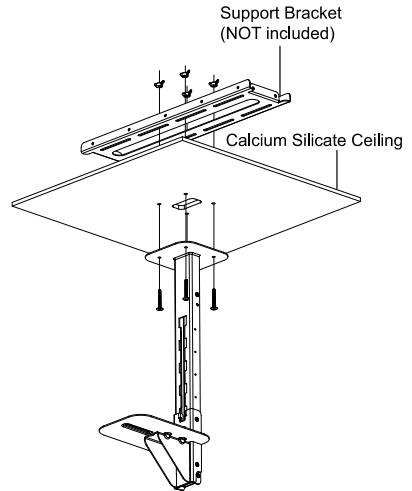

5. Connects all cables on the camera and pass all cables through the hole on the mount bracket. Organize all cables to pass through the hole on the ceiling. Also, the cable can go out from top or bottom of mount bracket.

6. Then, secure the camera on the camera bracket.

Screw: 2 UNC-1/4"-20 (Not included in package)

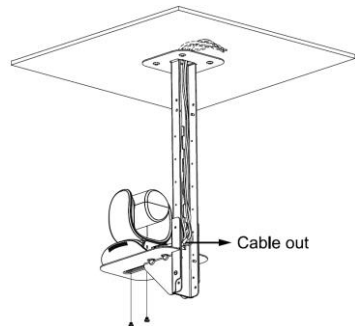

7. Next, secure the back cover with screws and washer.

Screw: 4 M8 x 4 + 4 Washer

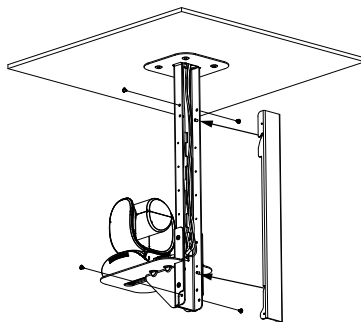

8. Completed.

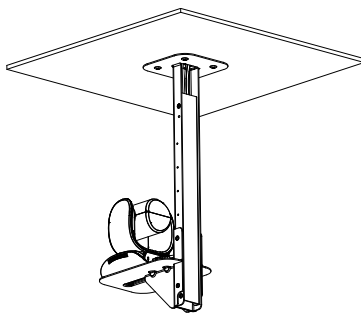

Secure the Cables

The USB and RS232 cables have a screw on the cable for securing cable on the camera.

Install the cable first and tighten the screw to secure the cable.

[Note] Make sure the cable is well connected to the connector on the camera before securing the cable.

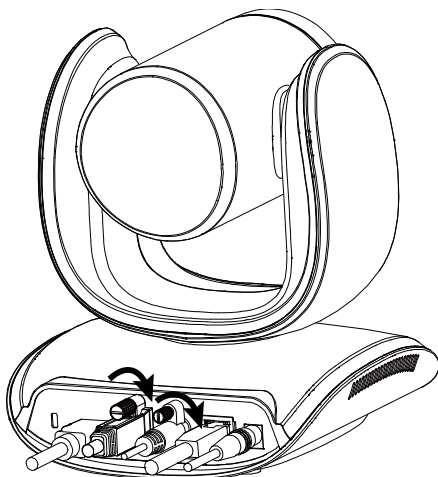

Operating the Camera

Make a Video Call

1. Make sure all devices (CAM550, laptop/PC, TV/monitor) are well connected and powered on.
2. Run your video application (Zoom, Microsoft® Teams, Skype for Business, Skype, Google Meet, Intel® Unite™, RingCentral, BlueJeans, V-Cube, LiveOn, CyberLink U Meeting®, TrueConf, Adobe Connect, Cisco WebEx®, Fuze, GoToMeeting™, Microsoft® Lync™, Vidyo, vMix, WebRTC, Wirecast, XSplit, etc.) on your PC or laptop.
3. Set the CAM550 camera as the primary camera for your video application (refer to your video application user guide). You can now make your call.

[Note] The CAM550 is a plug-and-play conference camera. The system requires no special drivers, but we do recommend installing the PTZApp 2 for a better user experience. For information on how to install and use the PTZApp 2, refer to the PTZApp 2 section in this user manual.

Make a Connection through the Browser

CAM550 has an Ethernet port for IP streaming and allows administrators to remotely control and set up the camera via an internet access. Moreover, CAM550 also supports RTSP and RTMP functions. For more details, please contact our technical support.

1. Make sure the CAM550 has an internet access connection.
2. Launch PTZApp 2* () and connect CAM550 to PC with USB cable. The camera default IP address is **192.168.1.168**.



[Note] The browser supports:

- Chrome: version 76.x or above
- Firefox: version 69 or above
- IE: Doesn't support

3. Click pencil icon (✎) to edit IP address**.

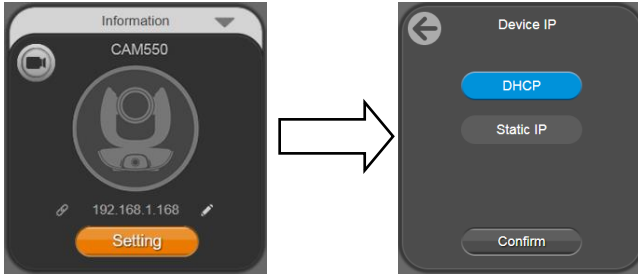

4. Click weblink icon (🔗) to launch Chrome page. Please enter the password (default password is **aver4321**). User will be asked to set a new account and password. (Please enter PTZApp 2 to reset password back to default while password is forgotten.)

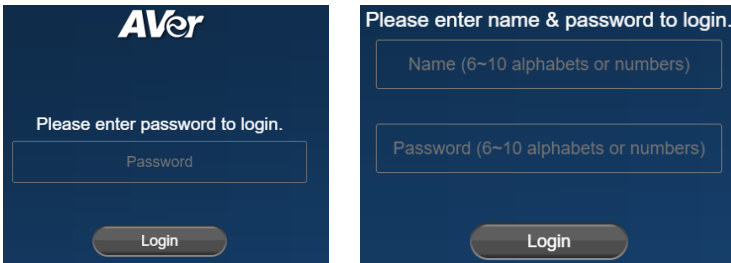

5. After editing IP address, user can access web settings of the camera with only Ethernet cable connection. Unplug the USB cable.
6. The main web screen is displayed as below.

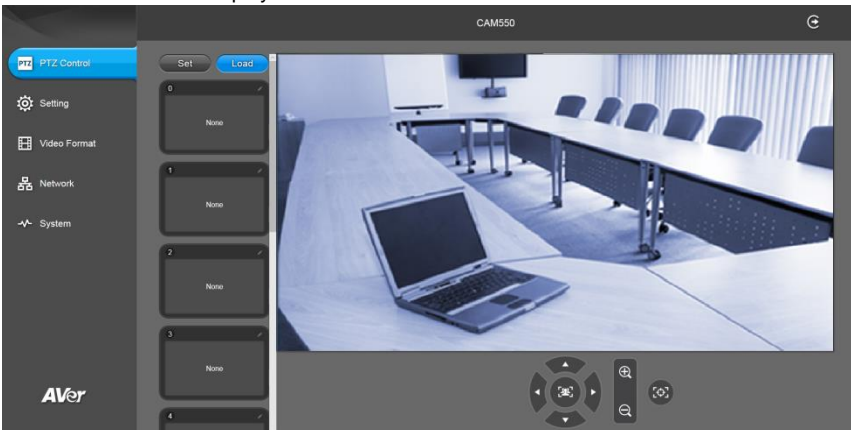

* For information on how to install and use the PTZApp 2, refer to the PTZApp 2 section in this user manual.

** To support IP address changes in groups, user can download AVer IP Finder app.

1. Download the IP Finder from <https://www.aver.com/download-center> (Global & European Headquarters) or <https://www.averusa.com/business/support/> (USA).
2. Run the IP Finder.
3. Click **“Search”**, and all available devices will be listed on the screen.
4. Select a camera from the list. The corresponding fields of IP address will display.
5. To change the IP address of camera, user can select **“DHCP”** or **“Static IP”**.

The DHCP should get the IP address from local dynamic IP sever. The static IP, user can enter the specific IP address. Click **“Apply”** to apply the setting to the camera. The password is required (default password is **aver4321**).

6. Click **“Search”** button to re-scan the camera.
7. Double-click on the IP address of camera from the list can connect to camera through the browser.
8. Enter the default password (**aver4321**) to login to Web setup screen.

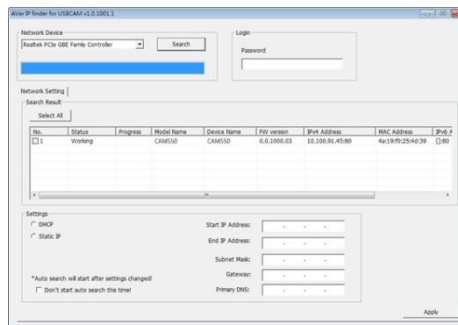

Web Settings

CAM550 supports Ethernet connection; users can enter the IP address into the web browser to connect to the camera for detail settings.

First Time Login

To find the IP address of the camera, please refer to **“Make a connection through the Browser”** section.

1. Open the browser on your laptop/PC and enter the IP address of the camera.
2. Enter the password at login screen. The default password is **“aver4321”**.
3. The main web screen is displayed.

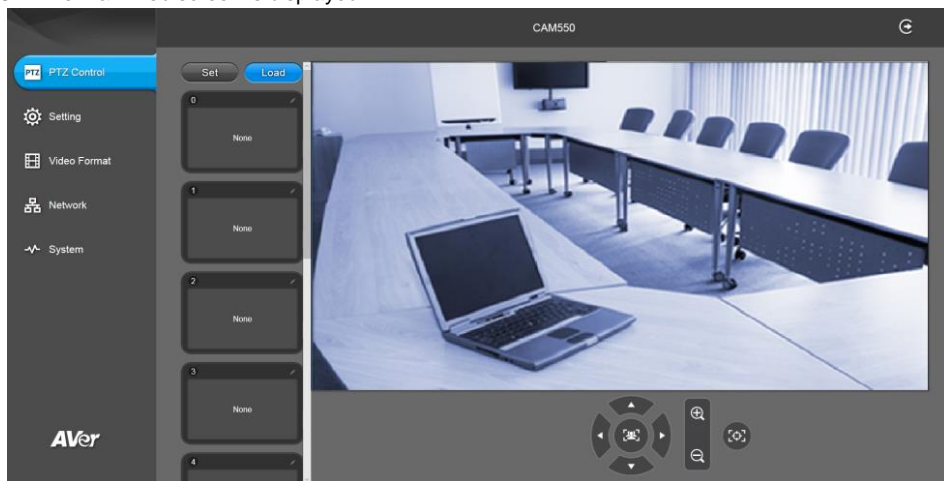

Live Screen Operation

User can control the camera direction, zoom in/out, and preset selection.

[Notes]

- The system will force the previous login to log out, when there is a second login.
If the web page is idle without any request for more than 4 hours, user will be logged out.
- The resolution of live screen is 1280x720 / 5fps.

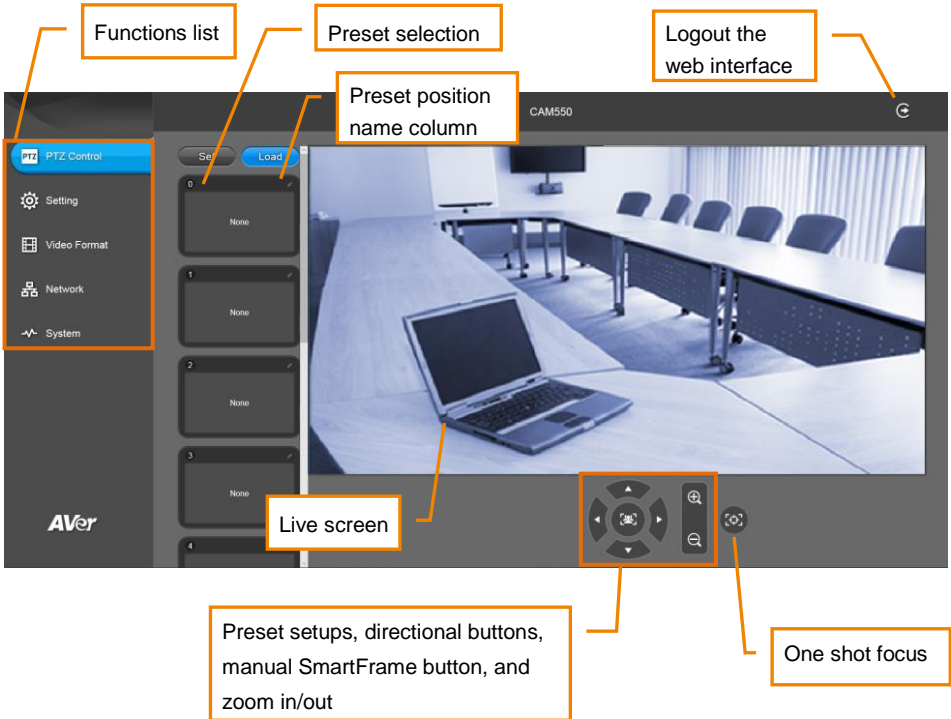

Set Up the Preset

User can set 10 preset positions.

1. In live screen, use ▲, ▼, ◀, ▶ and zoom in/out buttons to adjust the camera screen view to desired position.
2. Select **"Set"** button and click on the preset number to save the preset. The system will capture the preset screen view and display in preset number frame.

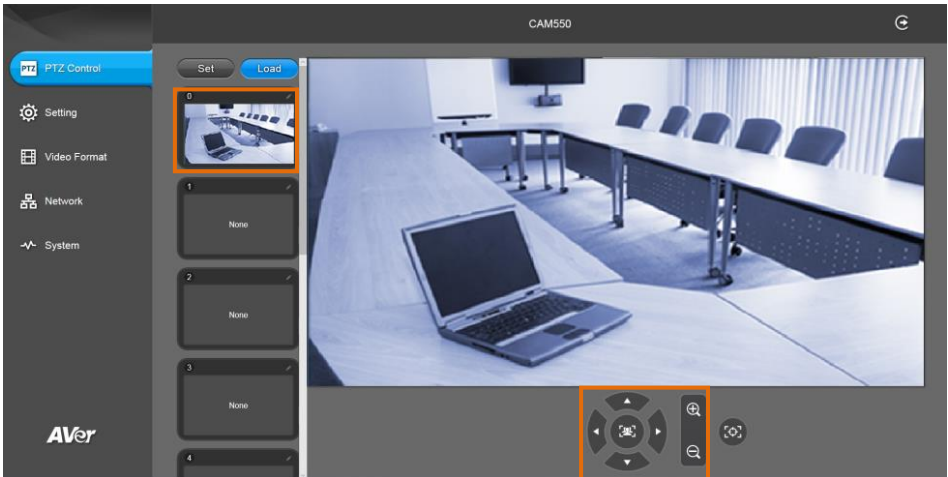

3. Select  icon to edit name of preset frame. Click other Web interface to save the name edited.

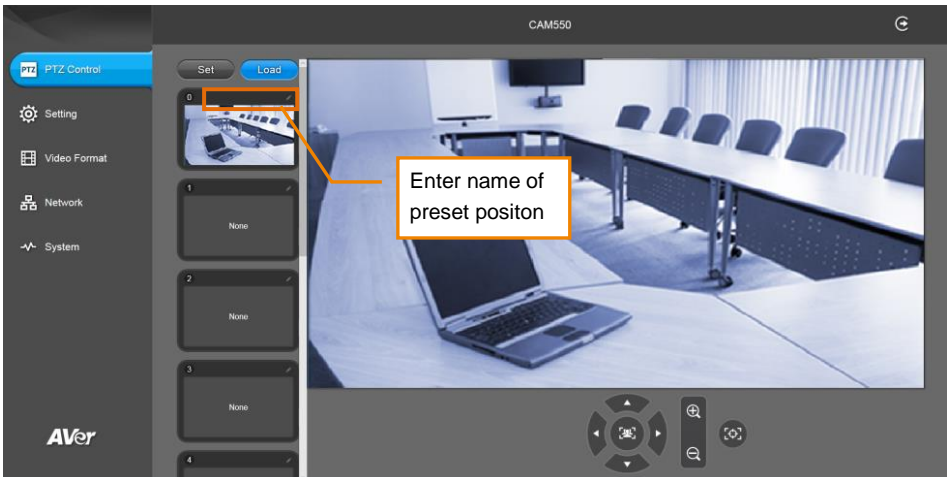

4. To set another preset, repeat the above steps.

5. After setting up the preset positions, you can start performing the function. Select the “**Load**” button and then click on the preset numbers, the live screen will move to the preset screen view.

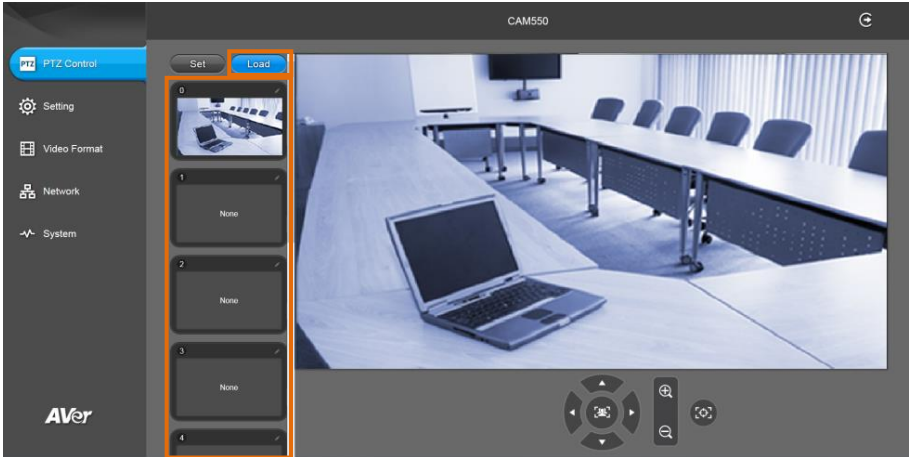

Camera Settings

The video  icon is to turn on camera live view while adjusting any settings.

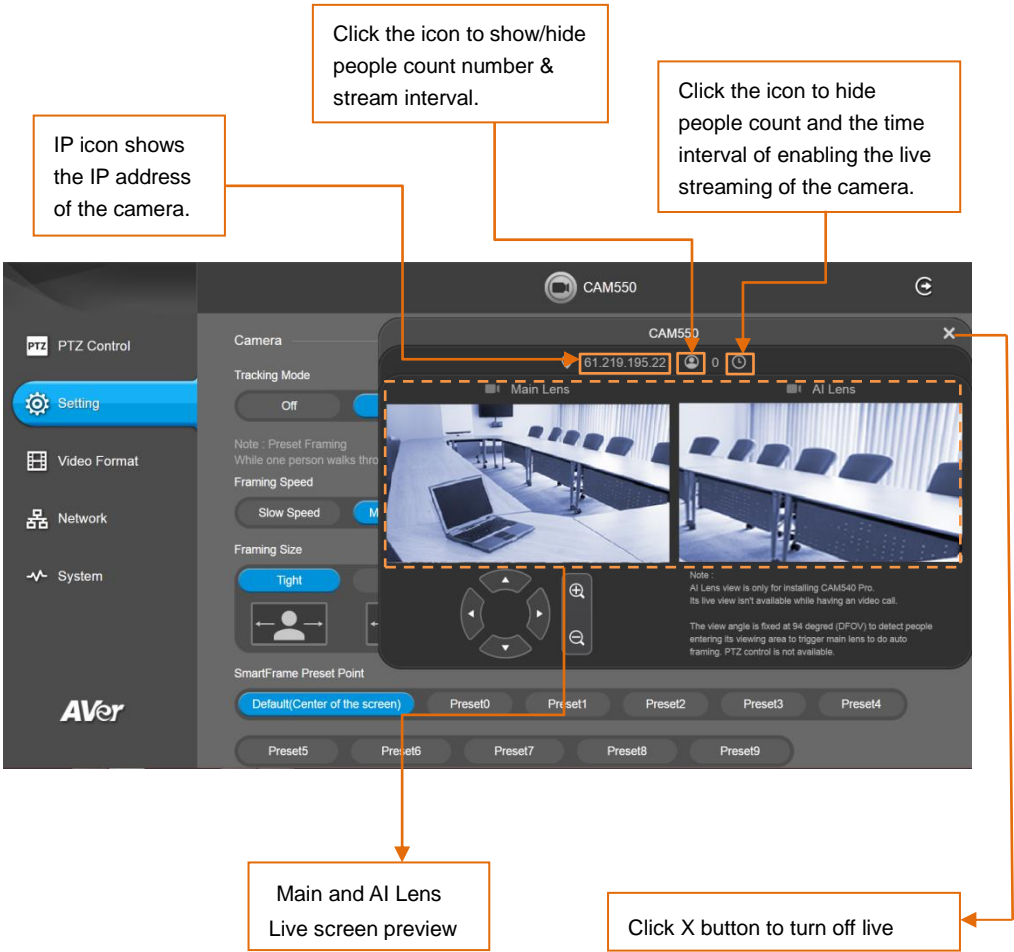

The screenshot shows the AVer PTZ Control interface for camera CAM550. The interface includes a left sidebar with menu items: PTZ Control, Setting (highlighted), Video Format, Network, and System. The main area displays camera settings such as Tracking Mode (Off), Framing Speed (Slow Speed), Framing Size (Tight), and SmartFrame Preset Points (Default, Preset0-9). A live video preview window is shown, split into Main Lens and AI Lens views. Callout boxes provide instructions: 'IP icon shows the IP address of the camera.' points to the IP address '61.219.195.22'; 'Click the icon to show/hide people count number & stream interval.' points to the '0' icon; 'Click the icon to hide people count and the time interval of enabling the live streaming of the camera.' points to the camera icon; 'Main and AI Lens Live screen preview' points to the video preview area; and 'Click X button to turn off live' points to the 'X' button in the top right corner of the video preview window.

Tracking Mode

Select **Setting > Camera > Tracking Mode > Off, Manual Frame, Auto Frame, or Preset Framing.**

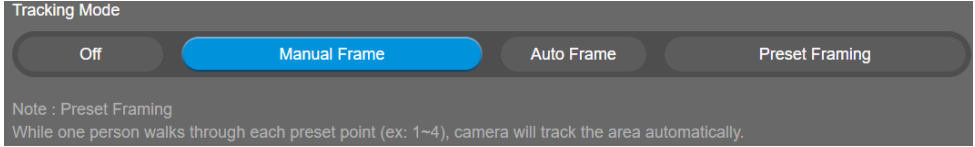

- **Off:** Tracking mode is disabled.
- **Manual Frame:** User one-click SmartFrame button and camera will adjust view angle to fit all participants in screen.

[Note] While in Auto Framing mode, or doing one-click manual frame, an icon message (👤) (to be shown when using HDMI out) will display on the upper left screen to indicate that the framing action is triggered. The icon will appear 2~3 sec on the screen. Once the framing process is done, it will disappear. If you don't want to see the icon display, please go to PTZApp 2, find “**On Screen Menu**” function and select “**Off**”.

- **Auto Frame:** AI lens (secondary lens) is with 95 degree panoramic view of the room to keep detecting all participants or new participants and trigger PTZ lens to dynamically frame all participants.

*The default framing speed is “Middle” speed. “High” speed is more suitable for one person tracking.

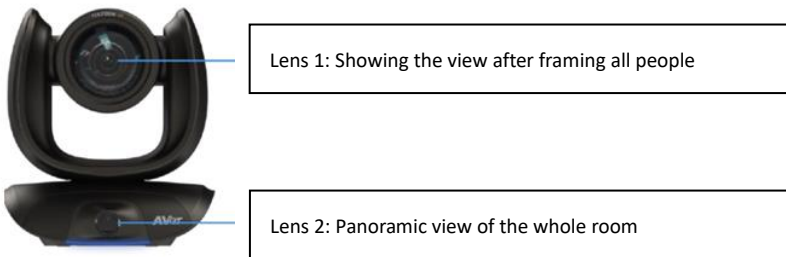

Please note that the angle of AI lens is larger than PTZ camera. If people at two sides of meeting room sit within AI lens view but out of PTZ lens' widest angle, they won't be framed and appear in the view of PTZ lens successfully. When this situation happens, please come closer to make sure people at two sides can be within PTZ camera's viewing angle.

[Note] If camera cannot find people while zooming out to wide, it will go Preset 0.

- **Preset Framing:** This is designed for requiring a specific zooming area with preferred image proportion. Set up preset points in advance. (Only for Preset points 1~9 and Preset 0 is for home position. The preset points must be within the AI lens angle of view.) Make sure the preset areas are within AI lens' view. When any of people enter a preset area, the PTZ camera

will immediately shoot the preset zones instead of focusing and zooming into presenter. PTZ Camera tracks and frames all the participants if none of them touch any preset area. To keep the screen stable, whenever there is a person in the area, the camera won't move any more until no one shows up. However, the camera can detect the direction where the last person goes. If the person goes to the next preset area with overlap section, the camera will directly move to the next preset area. Thus, to ensure smooth transition, please set up zones with overlapping presets.

If the preset zones do not overlap and when the last person leave the preset area, camera will zoom out to wide to find people and frame them again.

If more than 2 presets areas are touched by 2 persons, camera will go to preset 1. The priority is preset 1>preset2> preset 3....>preset 9



Separate preset area setting

Overlap beginning & end of each zone



Overlap preset area setting

[Note] CAM550 frames people in masks or any facial profile up to 7~10 meters away!



Framing Speed

Select **Setting > Camera > Framing Speed > Slow Speed, Middle Speed, or High Speed**(default).

When in auto framing or preset framing mode, camera will automatically frame people if they stand still without moving for 1-5 seconds.

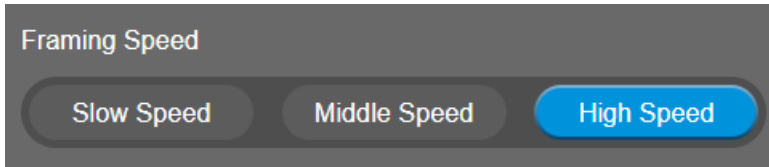

- **Slow Speed:** camera starts to frame people if they don't move for 5 seconds.
- **Middle Speed:** camera starts to frame people if they don't move for 3 seconds.
- **High Speed:** camera starts to frame people if they don't move for 1 second.

[Note] The default framing speed is "Middle" speed. "High" speed is more suitable for one person tracking.

Framing Size

Select **Setting > Camera > Framing Size > Tight**(default), **Medium**, or **Wide**.

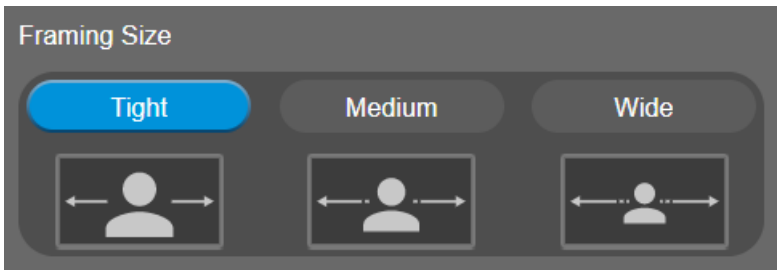

- **Tight:** It provides a close-up view of meeting participants.
- **Medium:** It provides a medium view of meeting participants.
- **Wide:** It provides a wide view of meeting participants.

Gesture Control

Enable gesture control allows user to use hand to control camera for turning on/off tracking function, zooming in/out. Click “?” icon to show gesture control list on screen.

[Note] The effective distance is up to 5-meter away from the camera.

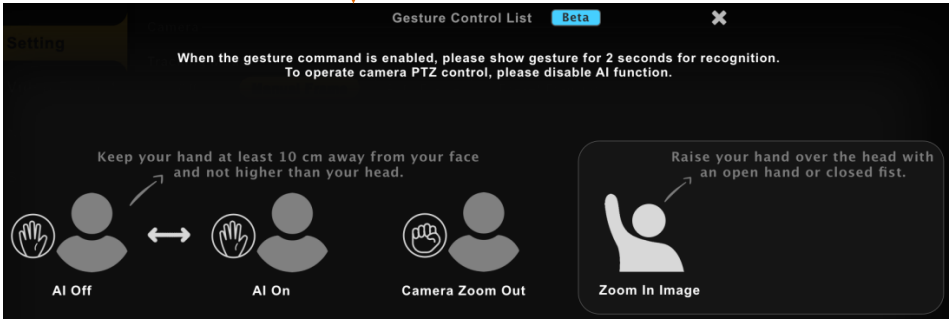
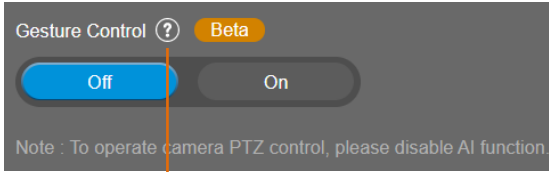

Turn on gesture control function first. When any of the following gestures are showing in front of the camera, it will activate gesture control function. Keep showing the gesture for 2~3 seconds to trigger the camera to act. The following are the corresponding function names and gesture figures.

Gesture Control	Description
<p>Tracking On/Tracking Off</p>	<p><u>You have to be in the view of PTZ lens.</u></p> <p>Raise the palm of your hand to face the camera and place it on the side of your face (not over the head) for 2~3 seconds to activate or disable tracking function. Your hand has to be at least 10cm away from your face.</p> <p>Turn off tracking function before doing zoom in/out function.</p>
<p>Zoom In</p>	<p><u>You have to be within the view of AI lens.</u></p> <p>Raise your hand over your head for 2~ 3 second to zoom in camera. If there are more than one people raising the hand, the camera will follow the 1st one until he puts down the hand.</p>

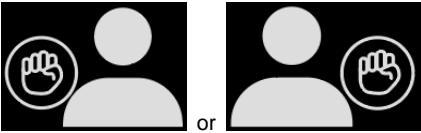
	Turn off tracking function before doing zoom in/out function.
<p style="text-align: center;">Zoom Out</p> 	<p><u>You have to be in the view of PTZ lens.</u></p> <p>Place a fist with palm facing the camera on the side of the face for 2~3 seconds to activate the zoom out. Your hand has to be at least 10cm away from your face.</p> <p>Turn off tracking function before doing zoom in/out function.</p>

Auto Focus

Set auto focus mode.

First select **Setting > Camera > Camera Focus > Auto**.

Select **Setting > Camera > Auto Focus > PTZ** or **Continuous**.



- **PTZ:** Click the button (such as pan, tilt, or zoom in/out) to adjust focus once.
- **Continuous:** The camera will adjust the focus when the objects have moved.

Camera Focus

Set auto/manual focus mode.

Select **Setting > Camera > Camera Focus > Auto** or **Manual**.

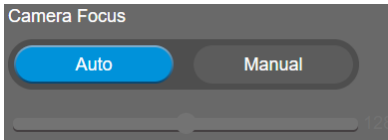

- **Auto:** Camera adjusts focus automatically.
- **Manual:** You can adjust the camera focus by moving the control bar below.

Home Position

Every time when powering on the camera, it will turn to this position.

Select **Setting > Camera > Home Position > Last Operation Position**, **Factory Center Position**, or **Preset 0**.

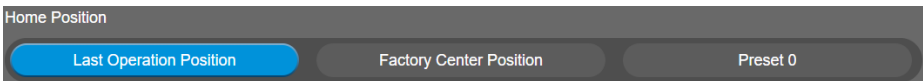

Sleep Position

When the camera idles for certain period, it will enter sleep mode and go to the sleep position. Please set up sleep timer to enable sleep mode.

Select **Setting > Camera > Sleep Position > Factory Downside Position or Preset 9.**



Sleep Timer

Set the camera idle time to enter sleep mode. When entering sleep mode, the camera will turn to sleep position.

Select **Setting > Camera > Sleep Timer > Off, 10 sec, 5 min, 10 min, or 20 min.**

Please notice that whenever there is USB streaming or RTSP/RTMP streaming, the camera won't enter sleep mode.

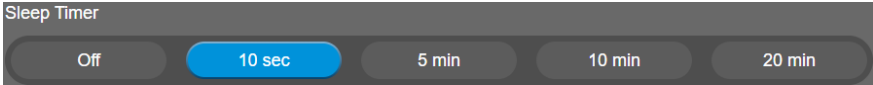

On Screen Menu

Enable/disable on screen display status information. For instance, when it is at auto frame mode, it will appear "AVS" on the upper left side of the screen. If you don't want to see the icon, please select Off.

Select **Setting > Camera > On Screen Menu > Off, On, or Load Preset Off.**



Camera Binding

With multiple cameras connection, users can set each camera to buttons 1 to 3 on the remote control.

Select **Setting > Camera > Camera Binding > Camera1, Camera2, or Camera3.**

[Note] When camera binding is off, press camera 1, 2, or 3 button on the remote control can control all the AVer USB camera nearby you.

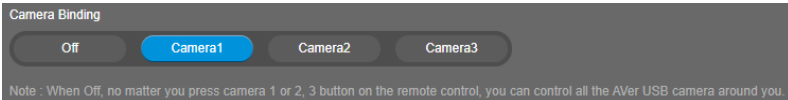

Save Preset

Enable/disable “save preset” function. When applicable, IT personnel can limit end-user access to change preset points by locking “save preset” function and switching this function off.

When off, user can't save preset points via IR remote, Hot key, VISCA, and webpage.

Select **Setting > Camera > Save Preset > Off** or **On**.

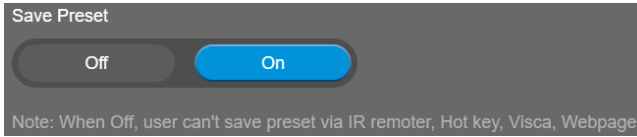

HDMI Screen Layout

To set HDMI output type – Lens 1, Lens 2, PIP 1, PIP 2, or PIP 3.

When select PIP 1, 2, or 3 layout, user can click  to switch lens 1 and 2 display position.

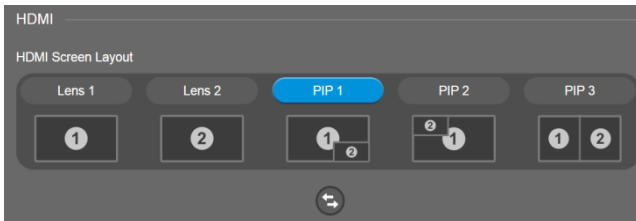

Image Settings

Frequency

Select the frequency of the camera.

Select **Setting > Image > Frequency > 50 HZ** or **60 HZ**.



Main Lens 1/AI Lens 2

Select Main Lens 1 or AI Lens 2 to setup lens' parameters – **White Balance**, **Noise Reduction**, **Brightness**, **Sharpness**, and **Saturation**. Those settings only apply for selecting lens.



White Balance

Select the white balance setting for various light conditions or color temperature.

Select **Setting > Image > White Balance > Auto** or **Manual**.

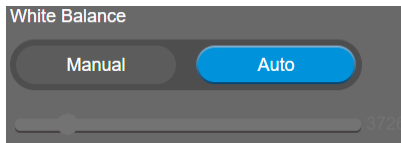

Noise Reduction

To reduce the noise from the signal.

Select **Setting > Image > Noise Reduction > Off**, **Low**, **Middle**, or **High**.



Brightness

Adjust the value of brightness.

Select **Setting > Image > Brightness > 1 ~ 9**.

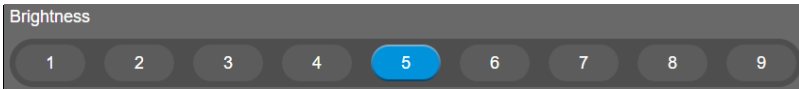

Sharpness

Adjust the value of sharpness.

Select **Setting > Image > Sharpness > Off, Low, Middle, or High**.



Saturation

Adjust the value of saturation.

Select **Setting > Image > Saturation > 1 ~ 9**.

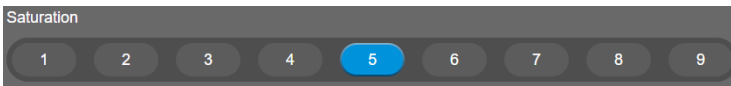

Low Light Compensation

Select **Setting > Image > Low Light Compensation > Off or On**.

Please notice that the frame rate will drop to 10~15 fps.

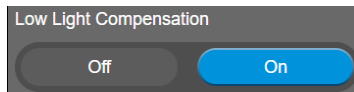

Allow Remote Access

Select **Setting > Image > Allow Remote Access > Off or On**.

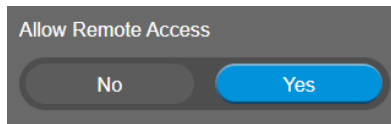

[Note] Only available on PTZApp2

Low resolution under 720p

Select **Setting > Image > Low resolution under 720p > Disable or Enable**.

Low resolution under 720p (except 848 *480)

Disable

Enable

Note :

1. While disable/enable low resolution, the system will reboot automatically and it will take around 20 seconds. Please wait.
2. In some video conference software, such as Teams, they may get lower resolution (360p) video streaming from camera to lower down the bandwidth loading during video call.

If you'd like to get better image quality during video call, please disable the output of resolution under 720p. The side effect will be lower frame rate, depending on different software providers.

Enlarge Total Zoom Up To 24x

Enable/Disable enlarge zoom up to 24x. The default is 18x.

Enlarge Total Zoom Up To 24x

Disable

Enable

RS232 Settings

When CAM550 connects with PTZ camera controller through the RS232 port, please setup **ADDR**, **Baud Rate**, **Protocol**, and **Visca Over IP** settings.

Select **Setting > RS232**.

ADDR

1 2 3 4 5 6 7 8

Baud Rate

2400 4800 9600 115200

Protocol

Visca Pelco-P Pelco-D

Visca Over IP

Off On

Video Format Settings

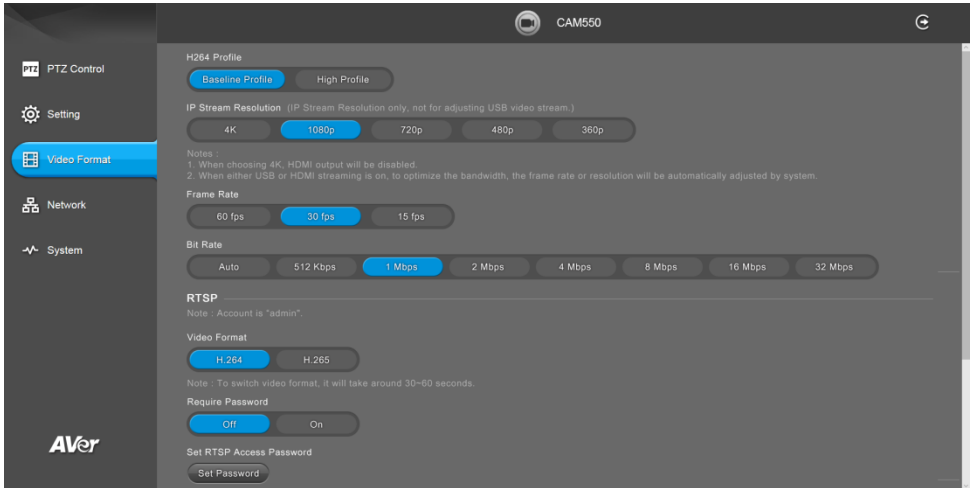

H.264 Profile

While in live broadcasting, user can choose preferable profile to get best streaming quality.

Select **Video Format > H.264 Profile > Baseline Profile** or **High Profile**.



IP Stream Resolution only

Set up the resolution for IP stream. Not supported for USB video stream.

Select **Video Format > IP Stream Resolution only > 4K, 1080P, 720P, 480P, or 360P**.

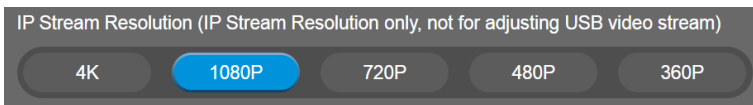

Please notice that if USB streaming (VC software side) is already in use at 1080p/30fps, the IP streaming resolution (RTSP) will be limited to 720p/30fps.

[Note]

- When choosing 4K, HDMI output will be disabled.
- When either USB or HDMI streaming is on, to optimize the bandwidth, the frame rate or resolution will be automatically adjusted by system.

Frame Rate

Set up the frame rate value.

Select **Video Format > Frame Rate > 60 FPS, 30 FPS or 15 FPS.**

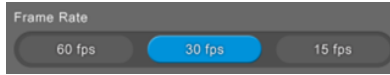

Bit Rate

Set up the bit rate value.

Select **Video Format > Bit Rate > Auto, 512 Kbps, 1 Mbps, 2 Mbps, 4 Mbps, 8 Mbps, 16 Mbps, or 32 Mbps.**

For Facebook live broadcasting, it's suggested to choose less than 4Mbps to ensure smooth streaming.



RTSP

To use RTSP player connecting to the camera, please enter the RTSP URL which displays on the web in your application such as VLC, PotPlayer, or Quick Time.

Select **On/Off** to enable/disable password requirement while opening RTSP.

[Note] Account is "admin"

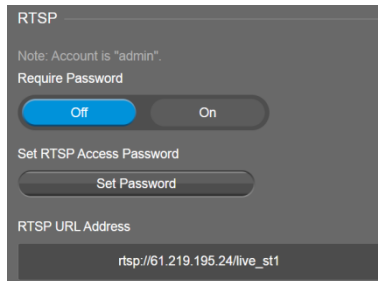

Set RTSP Access Password

1. Select **Video Format > RTSP > Set RTSP Access Password.**
2. Enter the new password.
3. Select **Change** to save the new password.

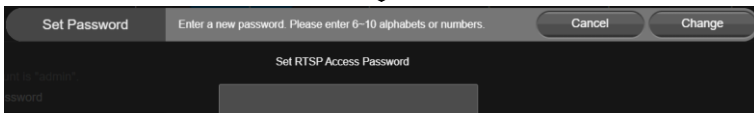
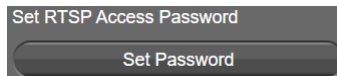

RTMP

Set up for uploading the camera's live view to the broadcasting platform (e.g. YouTube).

Select **Video Format > RTMP**.

1. Locate the RTMP server URL and stream key from the broadcasting platform and enter in **Server URL** and **Stream Key** fields.
2. Select **Start** to begin uploading the live video of the camera to the broadcasting platform.
3. Select **Stop** to stop uploading the video.

Note: Due to Facebook limitation, to ensure video quality, please set maximum Bitrate at 4Mbps.

Server URL

Stream Key

Start Using RTMP

Network Settings

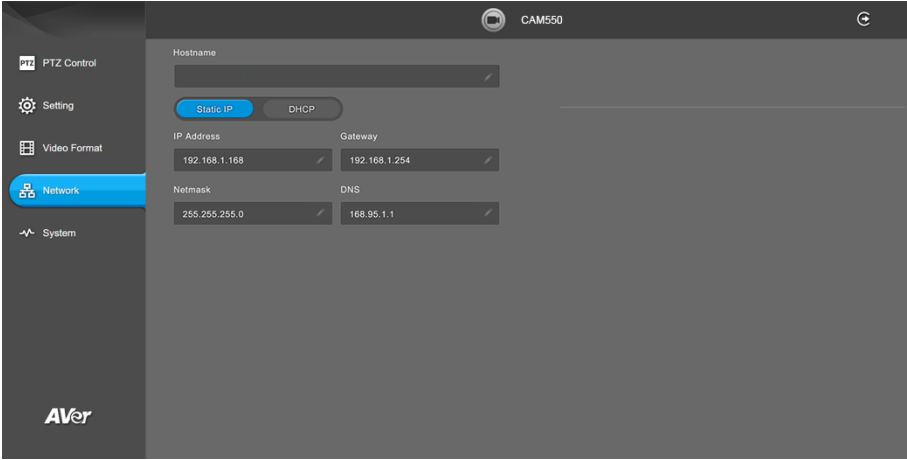

DHCP

Enable DHCP function.

Select **Network** > **DHCP**. A message is shown and clicks **Continue** to confirm.



Static IP

Assign a fixed IP address to the camera.

1. Select **Network** > **Static**.
2. Click pencil icon and enter the **IP Address**, **Gateway**, **NetMask**, and **DNS** in the corresponding fields.
3. Select **Confirm** to complete the setting.

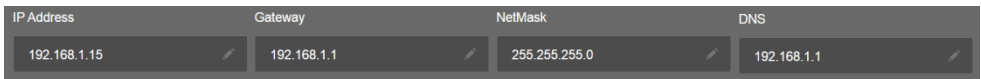

IP Address				Gateway				NetMask				DNS			
192	168	1	15	192	168	1	1	255	255	255	0	192	168	1	1

Confirm

System Settings

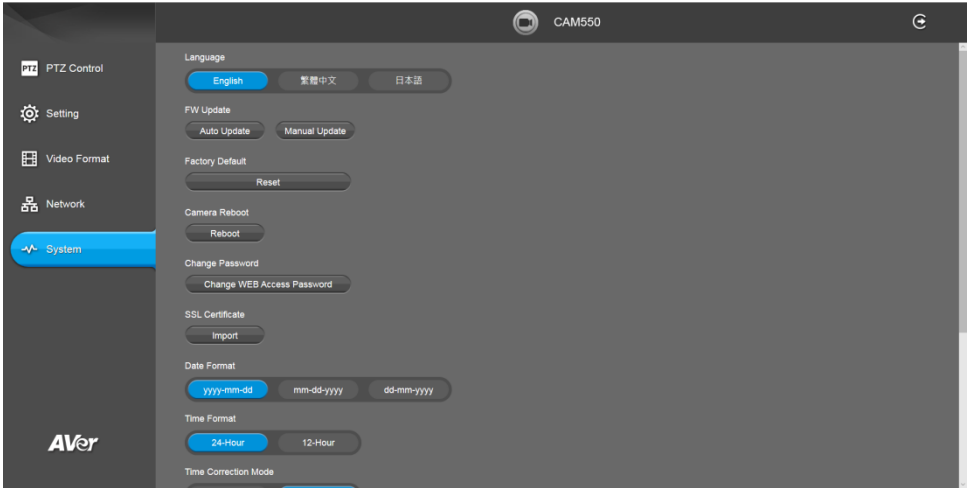

Language

Select the language of the system.

Select **System** > **Language** > **English**, **Traditional Chinese**, or **Japanese**.

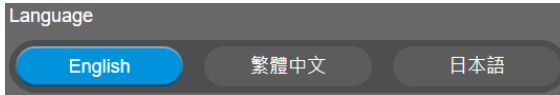

Firmware Update

Update the camera's firmware.

Select **System** > **FW Update** > **Auto Update** or **Manual Update**.

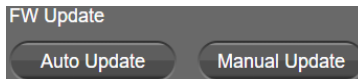

- **Auto Update:** The system will check firmware version from AVer server and request to update.
- **Manual Update:** To update the firmware from specific location.

After updating, the camera will **reboot** and the connection will be lost. Please wait for few minutes and always keep the power cable connected. If unplugging the power during this process, it will cause damage of the device.

Factory Default

Reset the camera back to factory default setting.

1. Select **System** > **Factory Default** > **Reset**.
2. User can choose to keep current IP address/Web access password or back to default.
3. Select **Continue** to reset back to factory default.

[Note] When factory default is activated, the password of Webpage login will not be set to default. For security concerns, to reset password of webpage access, please download PTZApp 2 to reset it.

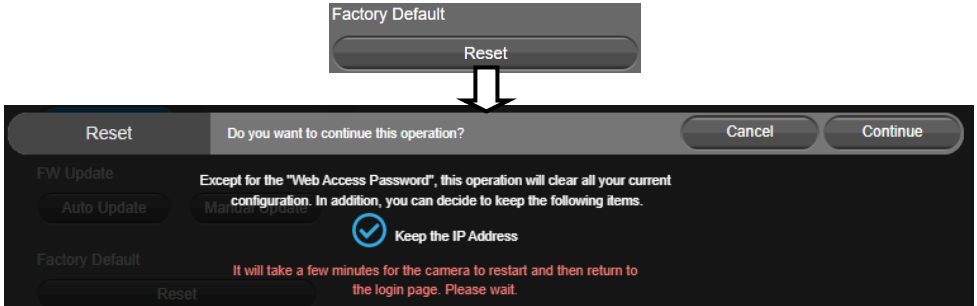

Camera Reboot

Restart the camera manually.

1. Select **System** > **Camera Reboot** > **Reboot**.
2. Select **Continue** to reboot the camera.

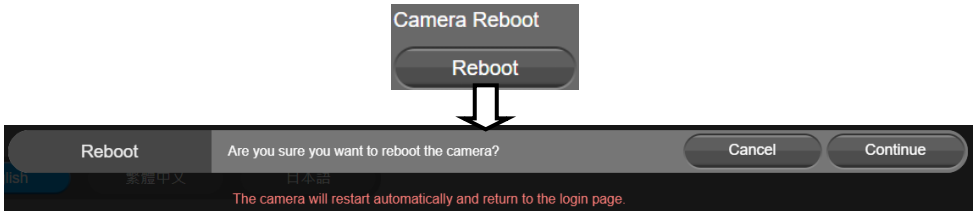

Change Password

Change the web login password. The default password is “**aver4321**”.

1. Select **System > Change Password > Change WEB Access Password**.
2. Enter the old account and password. Select **Continue**.
3. Enter the new account and password. Select **Continue** to save the new setting.
4. If users forget the password and want to revert back to the default password, please use PTZApp 2 to reset it.

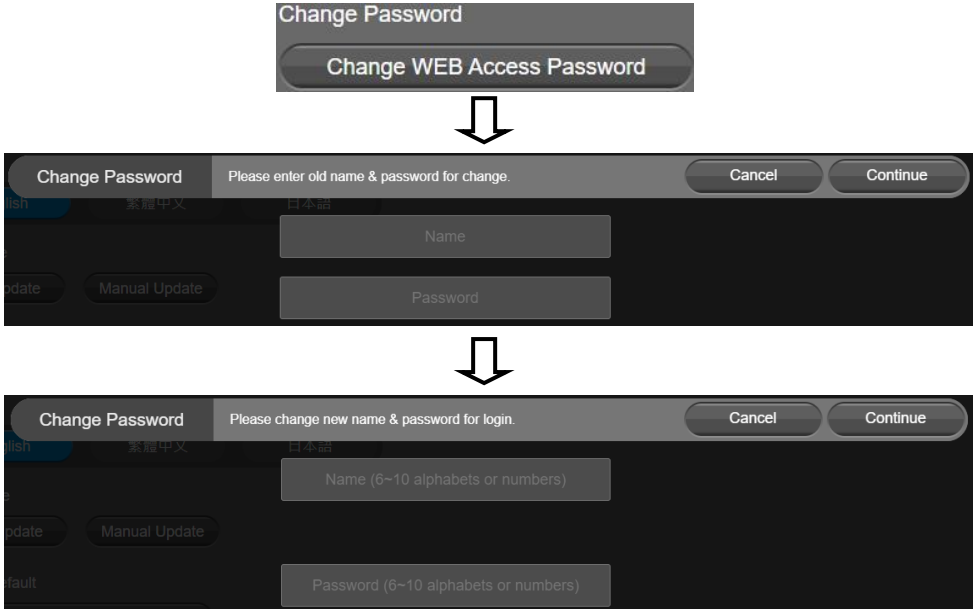

Trouble Shooting

Output log to save in local PC.

1. Select **System > Trouble Shooting > Start**.
2. Select **Output**.



[Note] Only available on PTZApp2

SSL Certificate

Import the SSL certificate from specific location.

1. Select **System > SSL Certificate > Import**.
2. Select the type by clicking "+".
3. Direct the file location.
4. Select **Import**.

[Note] If you want to disable SSL certificate function, please use PTZApp 2 to switch off this function.

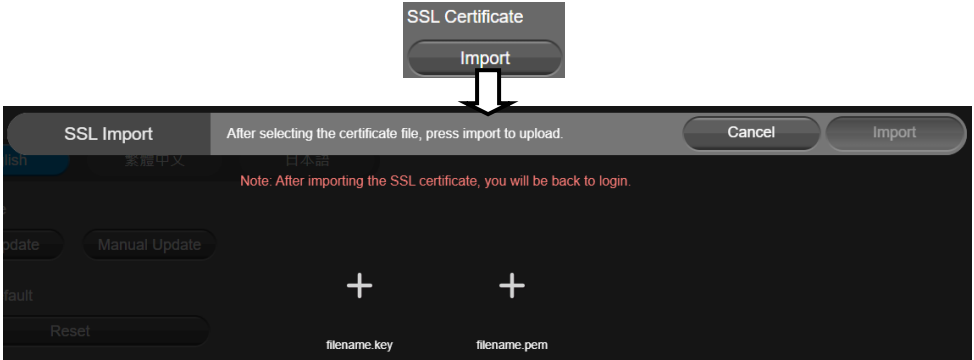

Date Format

Select the date format.

Select **System > Date Format > yyyy-mm-dd, mm-dd-yyyy, or dd-mm-yyyy.**

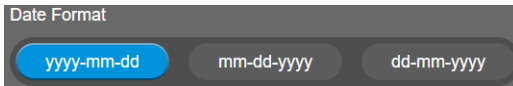

Time Format

Set up the time format.

Select **System > Time Format > 24-Hour or 12-Hour.**



Time Correction Mode

Adjust time automatically or manually.

Select **System** > **Time Correction Mode** > **Auto** or **Manual**.

- **Auto:** The system time will be set by NTP server on the network. Click the pencil icon of NTP Server and enter the URL of NTP server. Select the **Time Zone**. Select **NTP Update** to save setting. Select **Confirm** to start auto time adjustment.

[Note] Our default NTP server is located in the USA. If this does not work in your country, please manually key in the desired NTP server.

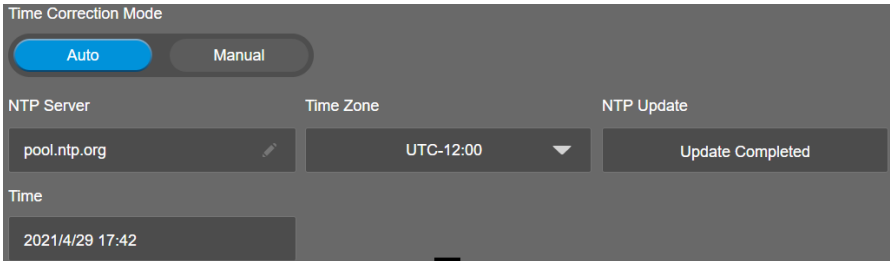

The screenshot shows the 'Time Correction Mode' interface with the 'Auto' button selected. The 'NTP Server' field contains 'pool.ntp.org', the 'Time Zone' is set to 'UTC-12:00', and the 'NTP Update' button is labeled 'Update Completed'. Below these fields, the current system time is displayed as '2021/4/29 17:42'.

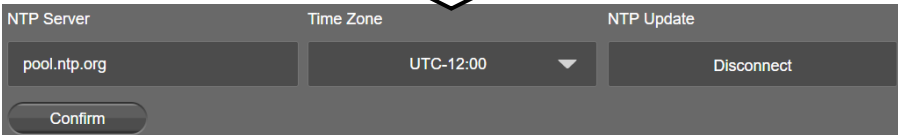

The screenshot shows the 'Time Correction Mode' interface with the 'Auto' button selected. The 'NTP Server' field contains 'pool.ntp.org', the 'Time Zone' is set to 'UTC-12:00', and the 'NTP Update' button is labeled 'Disconnect'. A 'Confirm' button is visible at the bottom of the interface.

- **Manual:** User can set up time manually. Click the pencil icon and enter the **Year**, **Month**, **Day**, **Hour**, and **Minute**. Select **Confirm** to save the settings.

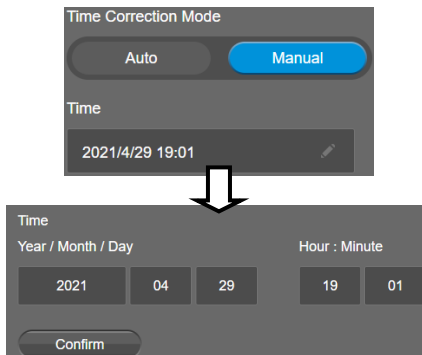

The screenshot shows the 'Time Correction Mode' interface with the 'Manual' button selected. The current system time is displayed as '2021/4/29 19:01'. Below the time display, there are input fields for 'Year / Month / Day' (2021, 04, 29) and 'Hour : Minute' (19, 01). A 'Confirm' button is visible at the bottom.

Information

Display the information of **Model Name**, **Firmware Version**, **Serial Number**, **IP Address**, and **MAC Address**.

Select **System > Information**.

Model Name	Firmware Version	Serial Number
CAM550	0.0.8000.10	51003581000
IP Address	MAC Address	
10.100.90.51	00:18:1A:09:6A:	

PTZApp 2

In PTZApp 2, user can change the IP address setting of CAM550, configure the parameters of the camera, set up AI tracking functions and some advanced image settings, pan, tilt, and zoom the camera.

Install PTZApp 2

Please go to <https://www.aver.com/download-center> (Global & European Headquarters) or <https://www.averusa.com/business/support/> (USA) to download the PTZApp 2. After downloading, double-click on the file and follow the on-screen instructions to complete the installation. After installing the PTZApp 2, double-click on the PTZApp 2 icon to run the application.

Use PTZApp 2 with USB Devices

1. Run your video application and make a video call.
2. During your video call, you can use the PTZApp 2 to pan, tilt and zoom the camera in/out and enable/disable the true WDR, brightness, and sharpness feature.
3. Launch PTZApp 2 () and it will open in Chrome browser automatically.

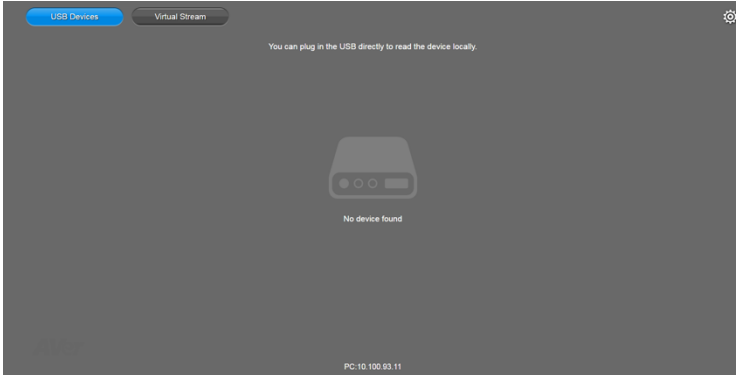

4. Choose “USB device” and connect CAM550 to PC/laptop with USB cable. When the camera is detected, the product card will show up.

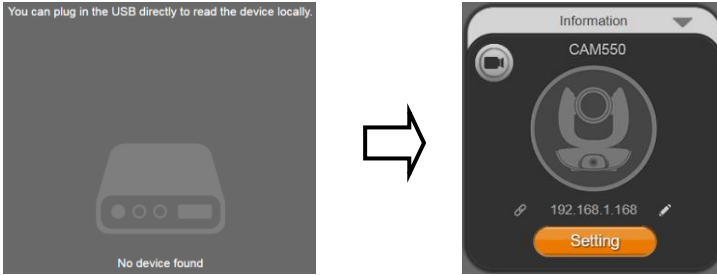

5. Set up IP address. The camera default IP address is **192.168.1.168**. Click pencil icon (✎) to edit IP address.

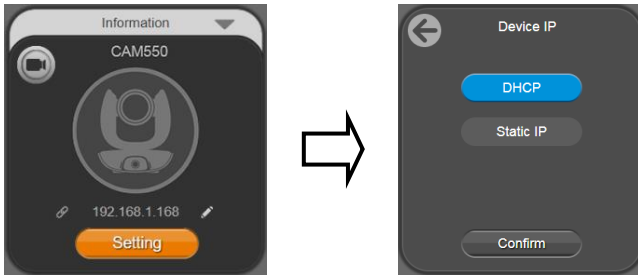

6. Click the setting icon to change Language, Hotkey Control, and PTZApp 2 Version.

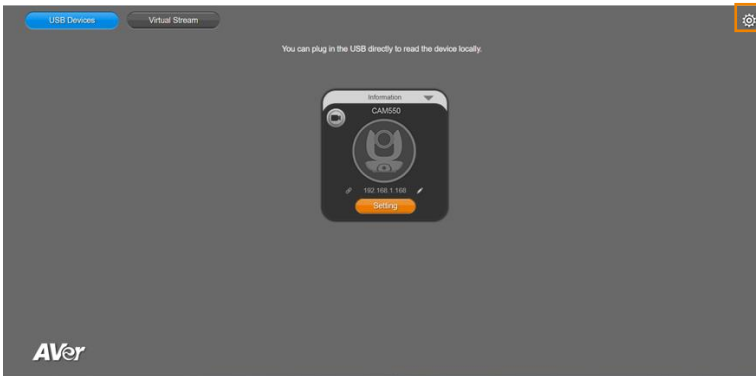

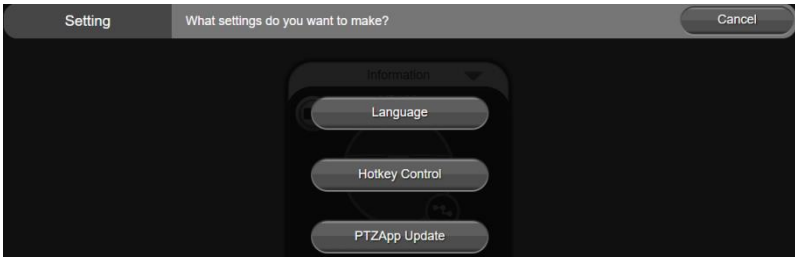

- **Language:** Select desired language and click the check icon to confirm the selection.



- **Hotkey Control:** User can control the camera by using keyboard. This is a general list for all AVer USB Cameras. Backlight control equals to WDR function in CAM550.

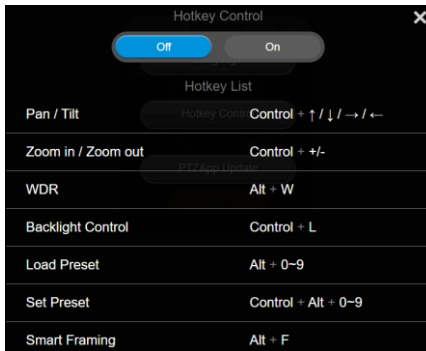

- **PTZApp Update:** Get current PTZApp 2's version number and do auto update here.







7. **Information:** Click the drop-down triangle icon to review the information of camera. To minimize the information, click the triangle or the bottom area of the information icon.

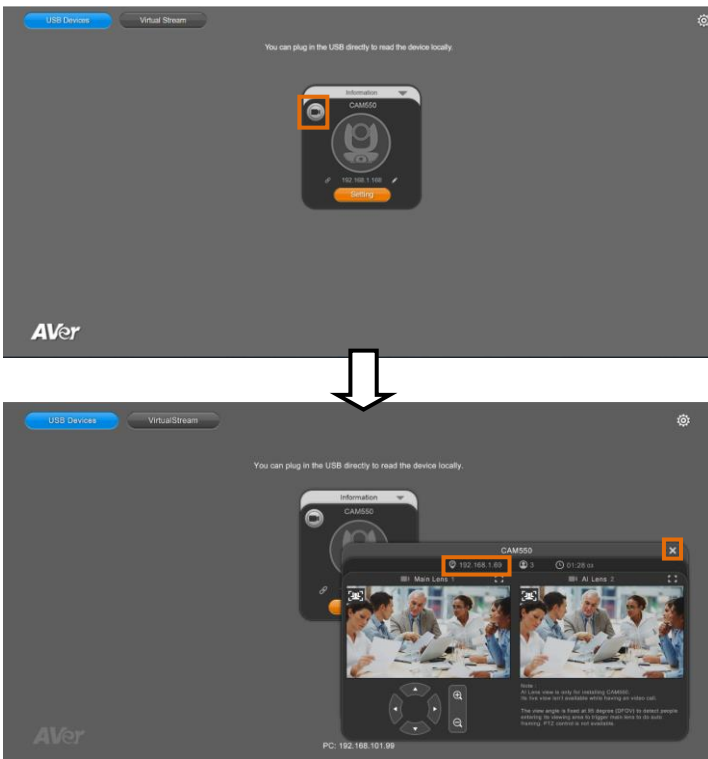

8. **Camera:** Click the camera icon to view the camera live view. IP address is displayed as well. Click the X icon to close the camera live view. If the live video did not appear, please check the camera and the laptop/PC connection to make sure all are correct and well connected.

The resolution of this small live view is 640x480 resolutions.



Full Screen: PTZApp 2 can switch to full screen mode. Click   icon and video screen will switch to full screen mode. In full screen mode, user can use direction panel to control camera direction. Click   icon to go back to normal screen view. The resolution of full screen mode is 1080p/ 30fps.



- **People Count and Stream Interval:** Click the  icon to show people count number and stream interval. Click the  or  icon to hide the stream interval.



- **Control Panel:** To control the camera direction, zoom in and out during your video call.



9. **Setting:** Click “**Setting**” button to set up parameters of the camera and speakerphone. Click arrow icon to leave the Setting page.

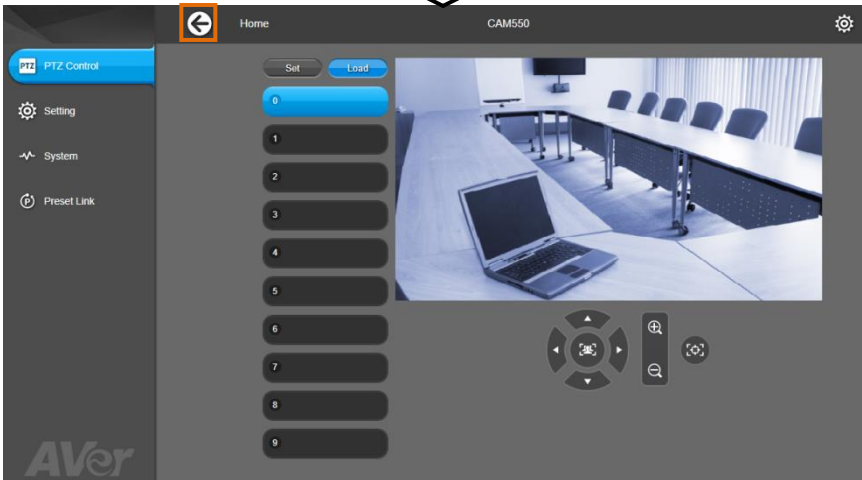

- **PTZ Control:** Use control panel to set up preset positions. Since most of operations are the same as web page, refer to [Set Up the Preset](#) section (pages 33) for detailed setup.
- **Setting:** To set up parameters of the camera. Since most of operations are the same as web page, refer to [Camera Settings](#) , [Image Settings](#) , and [RS232 Settings](#) section (pages 34~48) for detailed setup.
[Note] To set up RS232 parameters, please select “Off” for SSL Function on IP Web Page setting.
- **System:** To set up system. Since most of operations are the same as web page, refer to [System Settings](#) section (page 51) for detailed setup.

10. **PTZApp 2 Quit & Restore:** To quit the application, right-click the icon on the system tray and select **Quit**. If you can't launch PTZApp 2 right after installation, please right -click the icon and choose **Restore**.

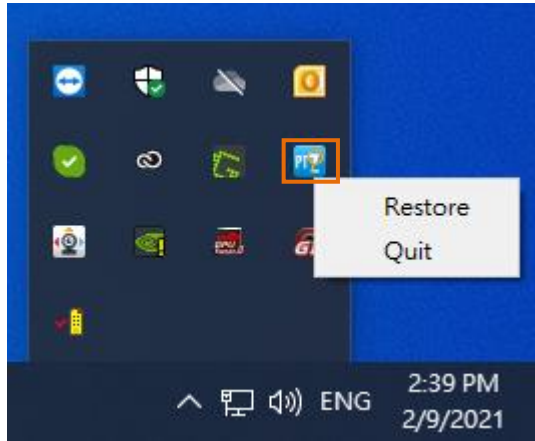

Use PTZApp 2 with a Virtual Stream

With this function, you can have a virtual meeting with only Ethernet connection and get rid of USB cable connection. Make sure the camera is connected with Ethernet and under the same subnetwork as the meeting room PC (e.g. NUC).

[Note]

While installing PTZApp2, if you refuse to install IP virtual streaming, Keystone Correction and Smart Gallery plug-in on your Windows PC (as photo below), you will not use Virtual Streaming function. If you would like to enable this function, please reinstall PTZApp2.

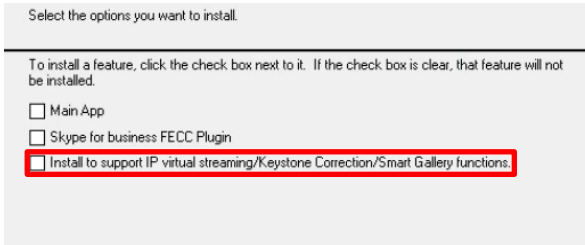

1. Launch PTZApp 2 (PTZ) on a PC and click Virtual Stream.

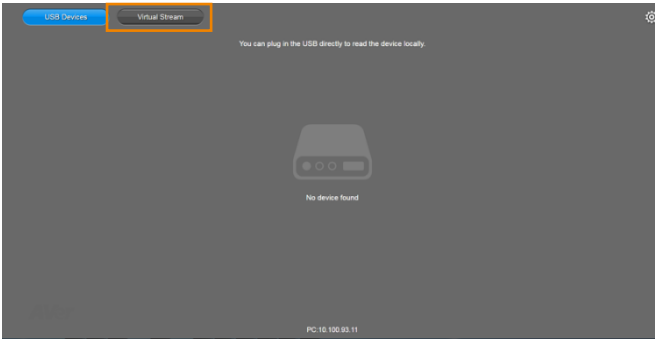

2. When the camera card appears, click **Start** to enable the Virtual Stream function.

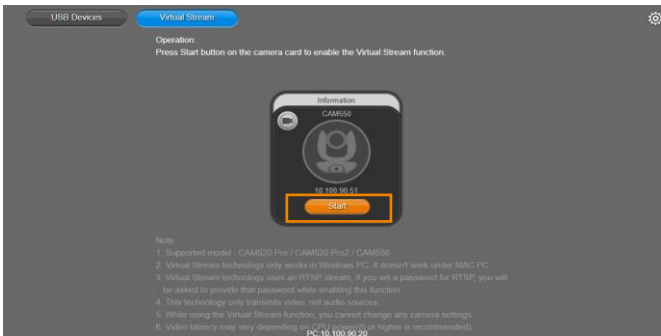

- Virtual Stream technology uses an RTSP stream. If you set a password for RTSP, you will be asked to provide that password while enabling this function.

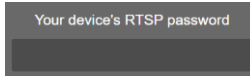

- Launch VC software (e.g. Zoom, Teams, Skype) and choose AVer USB VCam as the video source to start collaborating.
- While using the Virtual Stream function, you cannot change any camera settings. To pan/tilt or zoom in/out the camera, use a remote control or VISCA control.
- Click **Stop** and **Home** to stop using this function.

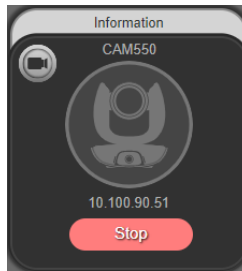

[Notes]

- This technology only transmits video, not audio sources.
- Video latency may vary depending on CPU power (i5 or higher is recommended).

EZLive

Please go to <http://www.aver.com/download-center> to download the AVer EZLive software. After downloading, double-click on the file and follow the on-screen instructions to complete the installation.

Use AVer EZLive

During a video call, EZLive can help user to do:

- (1) Camera ePTZ
- (2) Volume control for the speaker connected
- (3) Capture camera's still images
- (4) Record video
- (5) Live stream to Youtube, Livehouse.in, USTREAM...etc.
- (6) Camera Zoom in/out
- (7) Capture PC screen shot
- (8) Record PC screen video
- (9) Set up livestream
- (10) Open file management to retrieve photos and video files
- (11) Livestream setting
- (12) Drawing tool

